



Operation and Installation Manual

EFOY Pro 800
EFOY Pro 800 Duo
EFOY Pro 2400
EFOY Pro 2400 Duo

EN

Contents

Contents.....	1
1 Introduction	4
1.1 Foreword	4
1.2 Contact details	4
2 Safety Information	5
2.1 Explanation of safety alert signal words.....	5
2.2 General safety instructions.....	6
2.3 Safety instructions for methanol	7
2.4 Correct use	9
2.5 Certification	10
2.6 Warranty.....	11
2.7 Disposal and Transportation.....	12
3 Configuration	13
3.1 Standard equipment	13
3.2 Connections	14
3.3 Specifications.....	16
4 Installation.....	19
4.1 Installation space requirements.....	19
4.2 Mounting the fuel cell	22
4.3 Connecting the off-heat duct	23
4.4 Connecting the exhaust hose	25
4.5 Installing the fuel cartridge holder	27
4.6 Electrical connections	28
4.6.1 Electrical connection to the battery	29
4.6.2 Combination with other energy sources	32
4.7 Installing and connecting the operating panel.....	33
4.7.1 Flush mounting	33
4.7.2 Surface mounting.....	34
5 Operation	35
5.1 Operation on the device	35

5.2	Operation via the operating panel.....	36
5.2.1	Buttons and symbols on the operating panel.....	36
5.2.2	Initial commissioning	38
5.2.3	Info screen	39
5.2.4	Main menu.....	42
5.2.5	Expert menu.....	44
5.3	Remote control via computer	53
5.4	Fuel cartridges	54
5.4.1	Connecting the fuel cartridge.....	54
5.4.2	Selecting a fuel cartridge	57
5.5	Operating modes.....	59
5.5.1	Automatic	59
5.5.2	Manual On	60
5.5.3	Manual Off.....	61
5.5.4	External control	62
5.5.5	Remote On / Off	63
5.5.6	Hybrid.....	65
5.6	Automatic antifreeze feature.....	66
5.7	Shutdown	67
5.7.1	Switching off the fuel cell.....	67
5.7.2	Detaching the charge line and data line	67
5.7.3	Removing the EFOY fuel cartridge	67
5.7.4	Detaching the exhaust hose and off-heat tube	68
6	Maintenance	69
6.1	Service	69
6.2	Long term storage	69
6.3	Firmware update	70
6.4	Cleaning.....	71
7	Troubleshooting.....	72
7.1	Safety.....	72
7.2	Errors and solutions	73
7.2.1	Error message on the display	73
7.2.2	Errors without display messages.....	76

7.3	Adding EFOY service fluid	77
8	Data Interface and Optional Accessories	79
8.1	Data interface functionality.....	79
8.2	Communication Protocols.....	81
8.2.1	Modbus RTU	81
8.2.2	SIO / Plain text.....	92
8.3	GSM modem.....	93
8.4	Fuel cartridge sensor FS1	94
8.5	Cluster controller CC1	95
8.6	DuoCartSwitch DCS 1.....	97
9	Appendix	98
9.1	U-I and U-P characteristic	98
9.2	Output power characteristic	99

1 Introduction

1.1 Foreword

Thank you for choosing an EFOY Pro fuel cell from SFC Energy AG. We hope you enjoy using your new energy supply system.

Before you use the fuel cell for the first time, please read this user manual and follow the installation instructions.

Please contact your distributor in case you have questions about installation or operation.

Copyright by SFC Energy AG 2017. All rights reserved. Subject to change without notice.

1.2 Contact details

Headquarters

SFC Energy AG

Eugen-Saenger-Ring 7

85649 Brunnthal

Germany

Hotline: +49 89 / 673 592 555

Freecall*: 00800 / 732 762 78

eMail: service@sfc.com

Web: www.efoy-pro.com

*Calls can be placed free of charge from the landline from: Germany, Belgium, Denmark, France, Great Britain, Italy, the Netherlands, Norway, Austria, Sweden, Switzerland and Spain.

2 Safety Information

2.1 Explanation of safety alert signal words



DANGER!

Indicates an imminently hazardous situation, which, if not avoided, poses a high risk of death or serious physical injury.



WARNING!

Indicates a potentially hazardous situation, which, if not avoided, poses a medium risk of death or serious physical injury.



CAUTION!

Indicates a hazardous situation, which, if not avoided, poses a slight risk of mild or moderate physical injury or damage to property.



INFO:

Important information for the operator or user of the system.

2.2 General safety instructions

Read the user manual before commissioning the fuel cell, and keep the user manual close to the device at all times.

Follow all of the instructions in this user manual.



The EFOY Pro fuel cell must not be opened.

The EFOY fuel cartridge must not be opened or refilled using excessive force.

Modifications to the device constitute a safety hazard and may result in the loss of your operating license and nullify your warranty and guarantee.

Use original EFOY accessories only.



EFOY Pro fuel cells and EFOY fuel cartridges must not be stored at temperatures over +50 °C / +122 °F and must not be operated at temperatures over +50 °C / +122 °F.

Protect from heat and direct sunlight.

Operate the EFOY Pro fuel cell only as specified in the installation instructions, and in a well-ventilated space.



Keep EFOY Pro fuel cells that have been switched off in frost-free storage or use the automatic antifreeze feature.



Do not smoke in the vicinity of the EFOY Pro fuel cell or EFOY fuel cartridge. Protect from heat and ignition sources. Methanol is highly flammable!



Keep all EFOY Pro fuel cells and EFOY fuel cartridges out of reach of children, even when empty or only partly full.



WARNING!

In exceptional cases, the exhaust gases emitted by the device may contain substances that are harmful to health!

Do not inhale exhaust gases directly for prolonged periods. Instead, use the exhaust tube provided to route the exhaust gas into the open air.



WARNING!

Damage in the event of an accident; risk of injury!

EFOY Pro fuel cells and EFOY fuel cartridges must be securely fastened to prevent damage in the event of an accident.



WARNING!

EFOY Pro fuel cells must not be used in potentially explosive atmospheres.



CAUTION!

The EFOY Pro fuel cell is not water-tight!

Ensure that no water can enter the fuel cell.



CAUTION!

Improper use or improper connection to other electrical equipment may lead to damage.

2.3 Safety instructions for methanol



INFO:

There is no risk of you coming into contact with methanol provided that you handle the device and fuel cartridges in accordance with the instructions.

**DANGER!**

Leakage of methanol fumes poses a fire hazard! Do not smoke when replacing the EFOY fuel cartridge and do not expose it to other ignition sources! Protect EFOY fuel cartridges from temperatures exceeding +50 °C / +122 °F.

Leakage of a small quantity of methanol will evaporate, leaving no residue.

**WARNING!**

Methanol is highly flammable!

You receive methanol in safe, tested EFOY fuel cartridges, which prevent the contents from escaping if used correctly.

The storage and transport of methanol may be subject to statutory regulations.

For more information, refer to the safety data sheet on methanol, available on our website at <http://www.efoy-pro.com>.

**WARNING!**

Methanol is toxic when inhaled, swallowed or allowed to come into contact with the skin. Inhaling and swallowing methanol, or allowing it to come into contact with your skin carries a serious risk of irreversible damage.

Call a doctor immediately if you have direct physical contact with the substance, in the event of an accident, or if you feel unwell, and show the doctor the fuel cartridge label or the methanol safety data sheet.

**CAUTION!**

Impurities in methanol!

Original EFOY fuel cartridges contain methanol that has been approved by SFC. Even slight impurities or foreign particles in commercially available methanol may cause irreversible damage to the device, and may nullify the warranty or guarantee.

Use only original EFOY fuel cartridges!

2.4 Correct use

The EFOY devices produced by SFC Energy AG are automatic charging devices for 12 V or 24 V lead accumulators (batteries) or SFC qualified Lithium Iron Phosphate batteries (LiFePO₄). Please note the following:

- The devices must only be used to charge lead accumulators (batteries) that conform to the technical specifications of the device (see chapter 3.3 "Specifications" on page 16).
- The devices can be used according to the technical specifications for stationary and mobile operation in vehicles (see chapter 3.3 "Specifications" on page 16).
- The devices must only be operated with original EFOY fuel cartridges.
- The devices are not intended to be used as an emergency power supply for medical, life-sustaining or agricultural systems.
- Connecting several devices in parallel to increase the charging current is permitted.
- Connecting several devices in series to increase the voltage is not permitted.
- Devices with a defective or damaged housing must not be operated.
- The devices are intended for industrial use.

2.5 Certification

Declaration of conformity



SFC Energy AG, Eugen-Saenger-Ring 7, 85649 Brunnthal, Germany, hereby declares that the EFOY Pro 800, EFOY Pro 800 Duo, the EFOY Pro 2400 and the EFOY Pro 2400 Duo conform to the provisions of the EC Directive on electro-magnetic compatibility (2004/108/EC). The following harmonized norms apply:

DIN EN 61000-6-1, DIN EN 61000-6-3



Radio Frequency Interference (RFI) (FCC 15.105)

This equipment has been tested and found to comply with the limits for Class B digital devices pursuant to Part 15 of the FCC Rules. These limits are designed to provide reasonable protection against harmful interference in a residential environment. This equipment generates, uses, and can radiate radio frequency energy, and if not installed and used in accordance with the instruction manual, may cause harmful interference to radio communications. However, there is no guarantee that interference will not occur in a particular installation. If this equipment does cause harmful interference to radio or television reception, which can be determined by turning the equipment off and on, the user is encouraged to try and correct the interference by one or more of the following measures:

- Reorient or relocate the receiving antenna.
- Increase the separation between the equipment and the receiver.
- Consult the dealer or an experienced radio/TV technician for help.

Labeling Requirements (FCC 15.19)

This device complies with Part 15 of FCC rules. Operation is subject to the following two conditions:

(1) this device may not cause harmful interference, and (2) this device must accept any interference received, including interference that may cause undesired operation.

Modifications (FCC 15.21)

Changes or modifications to this equipment not expressly approved by SFC Energy AG may void the user's authority to operate this equipment.

Industry Canada Compliance Statement

This digital apparatus does not exceed the Class B limits for radio noise for digital apparatus set out in the interference-causing equipment standard entitled: "Digital Apparatus", ICES-003 of Industry Canada.

Cet appareil numérique respecte les limites de bruits radioélectriques applicables aux appareils numériques de Classe B prescrites dans la norme sur le matériel brouilleur : "Appareils numériques", NMB-003 édictée par Industrie Canada.

Seals of approval



The devices have been tested for electro-magnetic compatibility in accordance with ECE Regulation No. 10, and have been approved for use in motor vehicles.

Approval number: E24 10R-401275



The devices have undergone voluntarily testing by TÜV SÜD AG for conformity with the basic requirements of IEC 62282-5, and have been awarded the seal of approval for product safety.



This product is intended and certified for Canada and the USA. The product was voluntarily tested according to the safety requirements CAN/CSA-C22.2 No. 60335-1/R: 2007, CAN/CSA-C22.2 No. E60335-2-29:2006 and UL 60335-1/R:2006-04 (supplemented by UL 1564/R:2008-11, IEC 60335-2-29/A1:2004, CSA America FC-3:2004, NFPA 1192, ANSI/RVIS 12 V-low voltage systems, NFPA 70, UL 458).

2.6 Warranty

The warranty period begins with the purchase of a new device. You can use your sales receipt as proof of this date. Please keep these documents safe. Our warranty services are based on the warranty conditions of SFC Energy AG that are valid for the relevant country at the time of purchase. Please note the attached conditions of warranty.

Service

Please contact our EFOY hotline in relation to any technical questions about EFOY Pro fuel cells. The contact details are provided in chapter 1.2 "Contact details" on page 4.

2.7 Disposal and Transportation

Packaging

Your new device was packaged to ensure that it reached you safely. All materials used in the packaging are environmentally friendly and can be re-used.

We recommend that you keep the packaging in case it is needed for winter storage.

However, if you wish to dispose of the packaging, please help our planet by disposing of it in an environmentally responsible way and in accordance with the applicable local regulations.

Please note the instructions provided by SFC Energy AG when transporting the device. For information on this, refer to our website or contact the EFOY hotline. The contact details are provided in chapter 1.2 "Contact details" on page 4.



WARNING!

Plastic wrapping and cardboard boxes pose a risk of suffocation!

Please keep all packaging out of reach of children.

Fuel cartridges

Completely empty fuel cartridges can be disposed of with your plastic waste. Dispose of partly full fuel tanks in the same way as other hazardous waste, such as solvents and paint.

Old devices

Old devices are more than just worthless rubbish! Environmentally responsible disposal can reclaim valuable raw materials, while protecting the environment.

Old electronic devices must not be disposed of in your household rubbish. Observe the local regulations.

For advice on returning old devices, please contact the EFOY hotline. The contact details are provided in chapter 1.2 "Contact details" on page 4.

3 Configuration

3.1 Standard equipment

The EFOY Pro fuel cell SET includes the following equipment:

Part number	Description	Qty
-	Device EFOY Pro fuel cell	1
151 077 056	Operating panel OP2	1
151 075 033	Data cable DL2	1
151 905 021	Fuel cartridge holder	1
151 908 003	Belt for fuel cartridge holder	1
151 908 012	Mounting plate EFOY Pro	1
151 904 003	Insulated exhaust hose EH1	1
151 903 020	Off heat flange EFOY Pro	1
151 903 014	Off heat bow	1
151 903 001	Off heat tube	1
151 903 013	External face plate	1
151 903 025	Screw Set for off heat duct	1
150 903 001	EFOY service fluid	1
151 906 034	Charge line CL4	1
151 901 117	User manual EFOY Pro	1

The EFOY Pro fuel cell BASIC includes the following equipment:

Part number	Description	Qty
-	Device EFOY Pro fuel cell	1
150 903 001	EFOY service fluid	1
151 901 117	User manual EFOY Pro	1



WARNING!

Use original EFOY accessories only!
Use of unauthorized parts compromises safety and renders the warranty null and void.

A complete list of accessories and spare parts is available at www.foy-pro.com.

3.2 Connections

	#	Description
	1.	Connection for charge line
	2.	Connection for operating panel <i>Pin assignment see Remote Control</i>
	3.	Connection for data interface <i>Pin assignment see Data Interface</i>
	4.	Button
	5.	LEDs
	6.	Connection for exhaust hose and fill opening for EFOY service fluid
	7.	Connector #1 for EFOY fuel cartridge
	7.	Connector #2 for EFOY fuel cartridge (Only in model "Duo")
8.	Cooling inlet (reverse)	
9.	Warm-air outlet and connection for off-heat duct	

Remote Control

	Pin	Description
	1.	DuoCartSwitch DCS1
	2.	RxD (Operating panel OP2)
	3.	TxD (Operating panel OP2)
	4.	GND, Ground
	5.	Battery +
	6.	Fuel Cartridge Sensor FS1
	7.	Remote On
8.	M/S (Master/Slave) & Hybrid	

Data Interface

	Pin	Description
	1.	DuoCartSwitch DCS1
	2.	RS232 RxD (Receive Data)
	3.	RS232 TxD (Transmit Data)
	4.	GND, Ground
	5.	Battery +
	6.	Fuel Cartridge Sensor FS1
	7.	Remote On
	8.	M/S (Master/Slave) & Hybrid

3.3 Specifications

Performance data

Product	EFOY Pro 800	EFOY Pro 800 Duo	EFOY Pro 2400	EFOY Pro 2400 Duo
Max. rated output	45 W	45 W	110 W	110 W
Min. power output ¹	25 W	25 W	80 W	80 W
Nominal voltage	12 V / 24 V (Lead batteries)			
Max. charging current	3.75 A / 1.88 A	3.75 A / 1.88 A	9.17 A / 4.58 A	9.17 A / 4.58 A
Min. nominal charging current at 12 V / 24 V ¹	2.1 A / 1.05 A	2.1 A / 1.05 A	6.7 A / 3.3 A	6.7 A / 3.3 A
Recommended battery capacity ² at 12 V at 24 V	40 - 160 Ah 10 - 100 Ah	40 - 160 Ah 10 - 100 Ah	60 - 350 Ah 30 - 175 Ah	60 - 350 Ah 30 - 175 Ah
Switching thresholds for automatic battery charging at 12 V / 24 V ³	On: <12.3 V / <24.6 V Off: >14.2V / >28.4 V			
Required starting voltage at 12 V / 24 V	>9 V / >18.5 V			
Max. battery voltage at 12 V / 24 V	16 V / 30,5 V (Anti freeze mode up to 17 V / 32 V)			
Nominal consumption ⁴	0.9 l/kWh / 0.2 gallons/kWh			
Quiescent power consumption	With Operating panel, without light: 20 mA With Operating panel, with light: 33 mA Without Operating panel: 7 mA			

¹ Nominal power varies by $\pm 10\%$, decreases linear with the operation hours. Specification valid within warranty period.

² Depends on battery type and application - bigger batteries possible if charging current sufficient for battery (e.g. solar batteries).

³ Factory setting - can be modified with interface adapter and PC.

⁴ Effective consumption depends on operating conditions.

General data

Product	EFOY Pro 800	EFOY Pro 800 Duo	EFOY Pro 2400	EFOY Pro 2400 Duo
Number of fuel cartridges (with DCS1)	1 (2)	2 (4)	1 (2)	2 (4)
Sound pressure level at a distance of 1 m / 7 m (3.3 ft / 23 ft)	42 dB(A) / 25 dB(A)			
Weight	8.0 kg / 17.6 lbs	8.3 kg / 18.3 lbs	9.0 kg / 19.8 lbs	9.3 kg / 20.5 lbs
Dimensions	43.3 x 18.8 x 27.8 cm / 17.0 x 7.4 x 10.9 in			
Warranty	See chapter 2.6 "Warranty" on page 11.			

Installation requirements

Space requirement (LxWxH)	51.0 x 35.0 x 30.0 cm (minimum) / 20.1 x 13.8 x 11.8 in
Inclination along the direct axis	Permanent: 35° Temporary (<10 minutes): 45°
Inclination along the quadrature axis	Permanent: 20°
Operating temperature ¹	-20 °C to +50 °C / -4 °F to +122 °F
Starting temperature	+3 °C to +50 °C / +37.4 °F to +122 °F
Storage temperature	+1 °C to +50 °C / +34 °F to +122 °F
Recommended altitude ²	Up to 1500 m / 4920 ft

¹ At temperatures above +40 °C / +102 °F the power output can decrease.

² During operation above the recommended altitude the power output can decrease.



INFO:

All technical data tested under standard conditions. The specifications are subject to change without notice.

Equipment

Operation	On the device or via operating panel with text display
Data interface	RJ-45 plug for accessories (e.g. interface adapter)
Electrical interface	MNL plug, 4-prong (e.g. Tyco Electronics Universal Mate-N-Lok – No. 350779)

Fuel cartridge

Fuel cartridges	M5	M10	M28 (only with M28 adapter)
Volume	5 litres / 1.32 gallons	10 litres / 2.64 gallons	28 litres / 7.4 gallons
Weight	4.3 kg / 9.5 lbs	8.4 kg / 18.5 lbs	23.4 kg / 51.6 lbs
Energy capacity	5.5 kWh	11.1 kWh	31.1 kWh
Dimensions (L x W x H)	19.0 x 14.5 x 28.3 cm / 7.5 x 5.7 x 11.1 in	23.0 x 19.3 x 31.8 cm / 9.0 x 7.6 x 12.5 in	42.0 x 28.0 x 36.0 cm / 16.5 x 11.0 x 14.2 in

4 Installation

4.1 Installation space requirements

Installation should be carried out by trained personnel.

Ensure that there is sufficient unoccupied space behind the installation area before you drill or saw any openings. Please also observe the safety information provided by the tool manufacturers.



CAUTION!

Solvents may emit fumes during sealing. Ensure that there is sufficient ventilation and follow the instructions for using the sealing compound.



When choosing a location in which to install the fuel cell, please remember that the permitted operating temperature range for the device is -20°C to $+50^{\circ}\text{C}$ / -4°F to $+122^{\circ}\text{F}$.



CAUTION!

If the temperatures in the installation space exceed $+50^{\circ}\text{C}$ / $+122^{\circ}\text{F}$ the EFOY Pro fuel cell will shut down and not produce energy.

As soon as the temperature in the installation space fall below $+40^{\circ}\text{C}$ / $+102^{\circ}\text{F}$ the EFOY Pro fuel cell will start again fully automatic.



CAUTION!

The device requires an air supply and generates off-heat and exhaust gases. The off-heat and exhaust gases must be released into the open air.

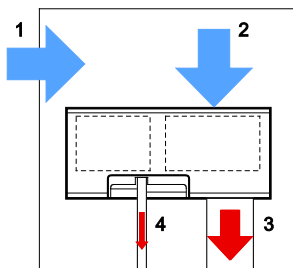

1. Opening for air supply for installation space
2. Air supply for heat exchanger and for stack
3. Off-heat from heat exchanger (see chapter 4.3 "Connecting the off-heat duct" on page 23)
4. Process exhaust air from stack (see chapter 4.4 "Connecting the exhaust hose" on page 25)

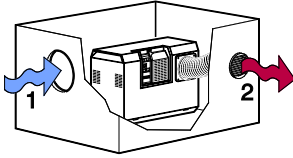

1. Supply air at least $\varnothing 10$ cm / $\varnothing 3.95$ in
2. Exhaust air

- The space in which the device is to be installed (including safety distance) must be at least L x W x H: 51 x 35 x 30 cm / 20.1 x 13.8 x 11.8 in.
- If the fuel cell is installed within a sealed container, provide an opening for supply air with a cross-section of at least $\varnothing 10$ cm / $\varnothing 3.95$ in – at structured openings (fine grid, narrow gap), accordingly more.
- Use the off-heat duct to conduct the off-heat out of the installation space (see chapter 4.3 "Connecting the off-heat duct" on page 23).
- The air openings of the installation space need to be protected against the penetration of water and foreign particles (e.g. using louvered metal sheets and fly screens).
- Ensure that there is sufficient ventilation in the installation space to prevent heat build-up. This can be done with additional openings or an additional temperature-controlled fan.
- The electrical connections, the fill opening for EFOY service fluid and the fuel cartridge must be easily accessible.

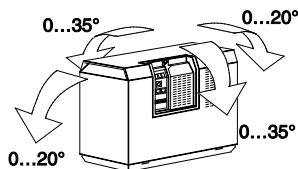

Install the device in an upright position only. Use the mounting plate provided for installation.



CAUTION!

Make sure that the device does not exceed the maximum inclination.

Inclination along the direct axis:	Permanent: 35° Temporary (<10 minutes): 45°
Inclination along the quadrature axis:	Permanent: 20°

Positioning the fuel cartridge

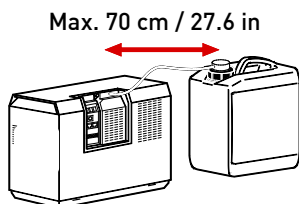

- When positioning the fuel cartridge, ensure that it is within reach of the fuel cartridge connection. The connection hose is 70 cm / 27.6 in long and must not be kinked or pinched at any point.
- The EFOY Pro 800 Duo and EFOY Pro 2400 Duo each have two 70 cm / 27.6 in hoses. Make sure that the fuel cartridge is within reach of both connections.



CAUTION!

The connection hose and exhaust hose must not be damaged or replaced by another hose.

Use only original EFOY connection hoses.

4.2 Mounting the fuel cell

1. Select a suitable location for installation as described in chapter 4.1 "Installation space requirements" on page 19.

Observe the dimensions in chapter 3.3 "Specifications" on page 16.

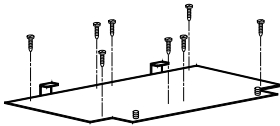

2. Secure the mounting plate tightly at the desired location. Use suitable screws and dowels, if necessary, to ensure that the mounting plate will remain in place even if significant force is applied to it, for example, in the event of an accident.

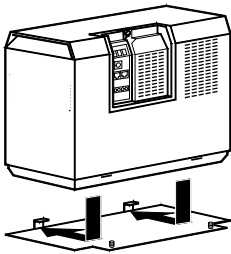

3. Place the device onto the mounting plate. The connections can be at the back, or as shown in the figure, at the front.

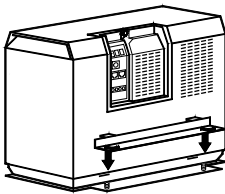

4. Place the mounting bar on the pegs on the mounting plate.

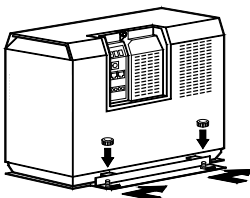

5. Slide the mounting bar onto the device and then to the right to lock it. Secure the bar using the two mounting nuts.

4.3 Connecting the off-heat duct

The off-heat duct supplied enables a controlled discharge of warmed air, which allows the device to be operated even in confined spaces.

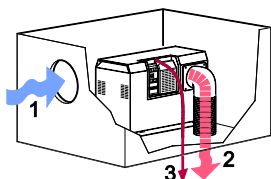

The off-heat of the heat exchanger needs to be conducted from the installation space to the outside sideways or downwards in a \varnothing 10 cm / \varnothing 3.95 duct.

The supply air side must not be guided by a duct to ensure that the installation space is well ventilated.

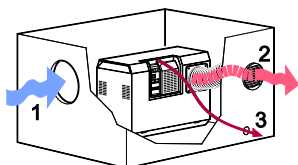

1. Supply air,
at least \varnothing 10 cm / 3.95 in
2. Exhaust air
3. Exhaust gas

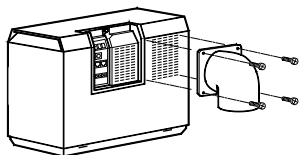

1. Sink the screws for the off-heat flange into the holes provided at the air outlet of the EFOY Pro fuel cell.
2. Attach the off-heat bow to the off-heat flange.

Use the off-heat bow to conduct warm air sideways or downwards. If you do not need the off-heat bow, you can connect the off-heat tube directly to the off-heat flange.

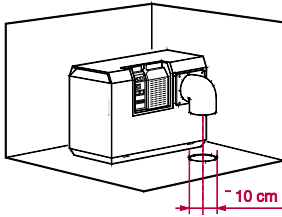

3. Attach the off-heat tube.
4. Take measurements to determine where to saw the duct opening. The duct opening should have a diameter of 10 cm / 3.95 in.
5. Saw a hole as a duct opening for the off-heat tube.



INFO:

Make sure that the off-heat tube has no kinks.

When drilling into spaces, ensure that no cables are located in these spaces.

When installing the fuel cell in vehicles, also ensure that you do not cut through any load-bearing parts of the vehicle. For more information, contact your vehicle manufacturer.

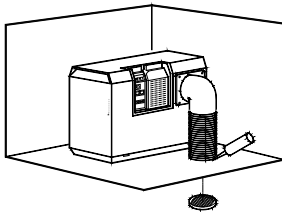

6. Feed the off-heat tube through the duct opening. You may shorten the tube, if necessary.
7. Use a suitable sealant to seal the duct opening to prevent moisture from penetrating into the interior of the fuel cell or the space around it. This is guaranteed if you use original EFOY accessories and if the fuel cell is installed correctly by a qualified professional.
8. Attach the external face plate to the external opening of the off-heat tube to prevent foreign bodies from entering the tube.

4.4 Connecting the exhaust hose

Within the EFOY Pro fuel cell methanol and oxygen are converted into water and carbon dioxide. This process creates heat, which needs to be conducted to the outside together with water vapor, carbon dioxide, and traces of methanol.



WARNING!

It is essential that the carbon dioxide is conducted into the open air via a hose.

Therefore connect the included exhaust hose and always evacuate the exhaust gases from the installation space or site to the outside.

Exhaust gases contain moisture and may exceed 60°C / 140°F during operation. This constitutes a scalding hazard. The exhaust gases may contain substances that are harmful to health. Avoid inhaling exhaust gases directly or for extended periods. The insulated exhaust hose must be vented outside.

It is possible to also collect the generated water in the installation space in a separate, vented water cartridge.

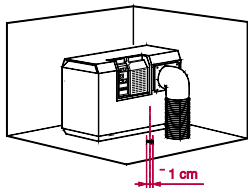
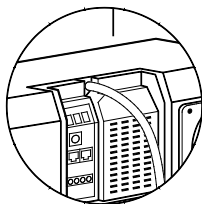

1. Remove the protective cap from the exhaust gas outlet of the EFOY Pro fuel cell. Keep this for winter storage or in case you need to return the fuel cell.
2. Attach the exhaust hose supplied to the exhaust gas outlet.
3. Take measurements to determine where to drill the duct opening. The duct opening should consist of a hole with a 1 cm / 0.4 in diameter.
4. Drill a hole for the exhaust hose.

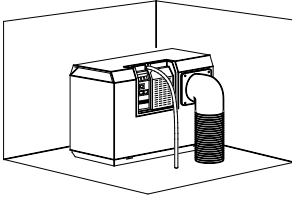

5. Feed the exhaust hose from the installation space through to the outside.
6. Use a suitable sealant to seal the hole. Ensure that the exhaust hose has no kinks or blockages and that the exhaust gases can flow freely out of it.

**INFO:**

Keep the exhaust hose as short as possible. The portion of the hose that penetrates outside should be no longer than 5 cm / 5.9 in. Cut the end of the hose diagonally to prevent drop formation.

The exhaust hose must not be damaged or replaced by another hose.

Take precautions to prevent the exhaust hose from freezing in winter.

The exhaust hose must be no longer than 50 cm / 19.7 in. It is essential to use hose insulation in winter. The exhaust hose may be up to 150 cm / 59.1 in long for summer operation and during transitional seasons.

Siphoning**INFO:**

Avoid siphoning in the hose as this prevents the passage of the exhaust gas.

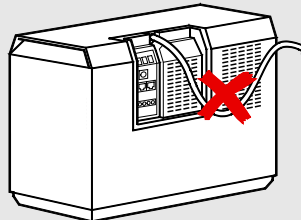
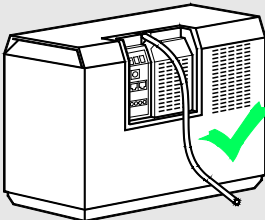

To prevent siphoning, ensure that the hose is pointing downwards.

4.5 Installing the fuel cartridge holder

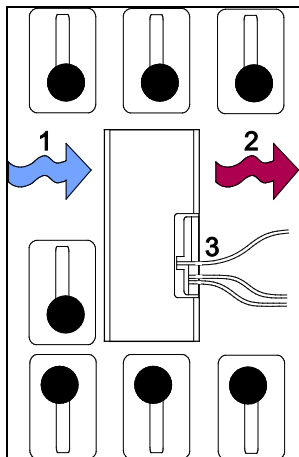

1. Supply air
2. Exhaust air
3. Connections

- Fuel cartridges and reserve fuel cartridges must not be placed in front of the inlet or outlet for the off-heat flow.
- Do not place any other objects in front of the inlet or outlet for the off-heat flow.
- Observe the instructions for positioning the fuel cartridge on page 21.

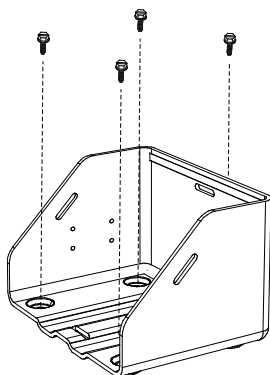

- Secure the fuel cartridge holder with four screws and, if necessary, with dowels to ensure that it will remain in place even if significant force is applied to it, for example, in the event of an accident.

4.6 Electrical connections



WARNING!

All electrical work must only be carried out by qualified electrical technicians in accordance with the relevant legal provisions.

Laying cables incorrectly or using the wrong cable size may result in a fire hazard.

All connected cables must have sufficient insulation and adequate proof voltage, and the connectors must be scoop-proof. The laying of un-insulated cables and pins is not permitted.



INFO:

Use the cable harness supplied to connect the device.

The charge line must be connected to the battery using a fused circuit.

Always connect both charge lines (sensor line and power line).

Preferably run separate lines for charging (power) and for voltage measuring (sensor) to the battery, otherwise the flow of current will cause false voltage readings.

4.6.1 Electrical connection to the battery



INFO:

The EFOY Pro charges the connected battery and the battery supplies the power to the application or to the electrical loads.

The EFOY Pro must only be used to charge lead batteries that conform to the technical specifications of the device (see chapter 3.3 "Specifications" on page 16).

The EFOY Pro can charge 12 V and 24 V batteries (Factory settings: lead batteries; Adjustable: LiFePO4) and automatically detects which battery voltage is connected.

The charging parameters for automatic mode can be adjusted individually using the expert menu in the operating panel (see chapter 5.2.5 "Expert menu" on page 44) or using a computer (see the user manual for the interface adapter).

The settings and parameters for LiFePO4 batteries can be found in chapter 5.2.5 "Expert menu" on page 44.

To protect the battery, the additional use of deep battery protection is recommended to disconnect the load from the battery when the battery voltage is low.

Check polarity before you connect the device.

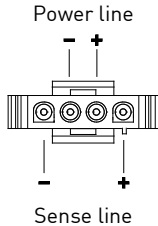
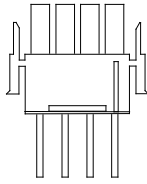

- The charge line comprises four lines. The two power lines charge the battery with electricity. The two sense lines measure the battery voltage.
- The following cable cross-sections are recommended to minimize ohmic drops in the charge line, if the battery charge line supplied is not long enough:

Length	Minimum cable cross-section
< 5 m / 16.4 ft	2.5 mm ² / 0.004 sq in AWG 13
5 – 10 m / 16.4 – 32.8 ft	4 mm ² / 0.006 sq in AWG 11
10 – 15 m / 32.8 – 49.2 ft	6 mm ² / 0.009 sq in AWG 9

Optional accessories

Extension sense line 8 m / 26.2 ft (Art. No.: 151 906 005)

Extension power line 8 m / 26.2 ft (Art. No: 151 906 006)

Connection diagram

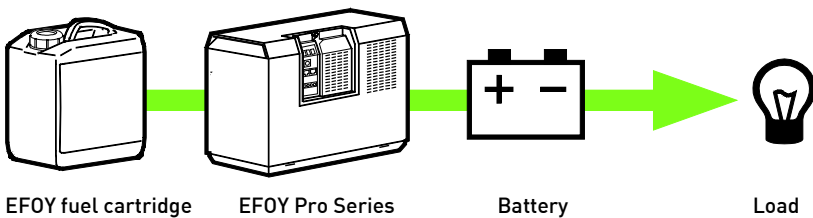

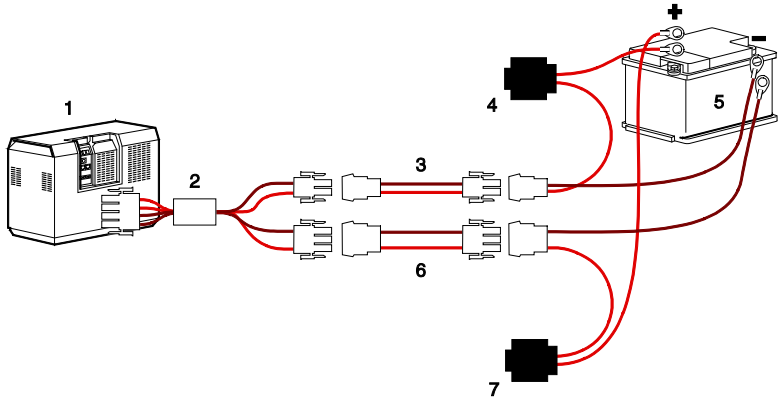

1. EFOY Pro fuel cell
2. Connecting line to EFOY Pro fuel cell
3. Extension cable sense line 8m / 26ft (optional accessories)
4. Battery protection in sense line with 2 A fuse
5. Battery
6. Extension cable power line 8m / 26ft (optional accessories)
7. Battery protection in power line with 15 A fuse

4.6.2 Combination with other energy sources



CAUTION!

When connecting a charge controller with temperature compensation please consider the maximum battery voltage of the EFOY Pro fuel cell (see chapter 3.3 "Specifications" on page 16).

The EFOY Pro can be combined with other energy sources, which then charge the battery together. The EFOY Pro is often used in combination with a photovoltaic system.



INFO:

In the case of a combination with other energy sources it is recommended to adjust the switch-on thresholds of the EFOY Pro so that the device only switches on if solar alone does not provide enough energy (e.g. in winter).

Connection diagram

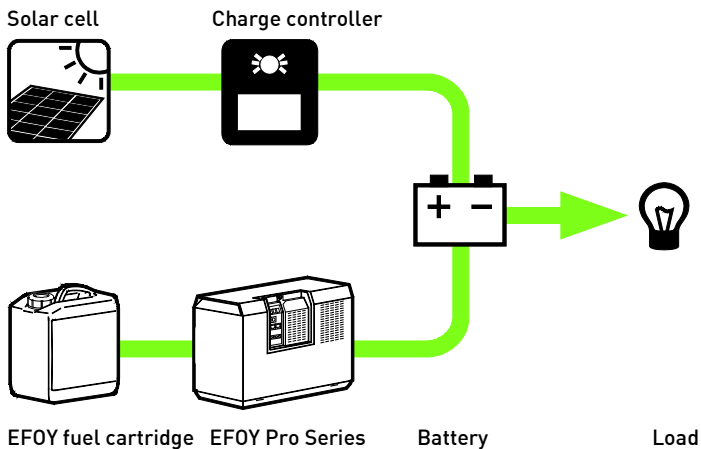

4.7 Installing and connecting the operating panel

The operating panel displays the current status of the device and is used to operate the EFOY Pro fuel cell. Mount the operating panel in an easily accessible location.

4.7.1 Flush mounting

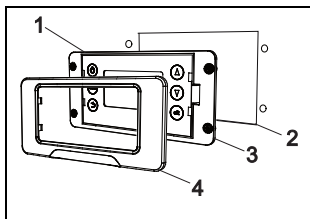

INFO:

Ensure that there is sufficient space for the electrical components behind the opening.

1. Operating panel
2. Opening
3. Screws
4. Frame

1. Use the drilling and sawing templates provided for flush mounting.
2. Use a drill to start the opening.
3. Use a jigsaw to saw an opening for the flush mounting.
4. Connect the operating panel to the data line DL2 supplied.
5. Secure the operating panel with four suitable screws.
6. Then attach the frame to the operating panel.

4.7.2 Surface mounting

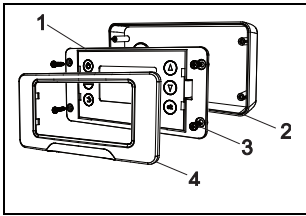

1. Operating panel
2. Surface-mount housing
3. Screws
4. Frame

1. Attach the operating panel securely to the surface-mount housing with four suitable screws.
2. Attach the frame to the operating panel.
3. Connect the operating panel to the data line DL2 supplied.

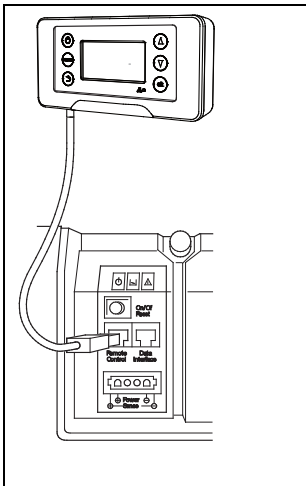

4. Securely attach the surface-mount housing to the mounting surface with a suitable detachable connection (e.g. Velcro strip).
5. Insert the data line plug into the left socket on the EFOY Pro fuel cell marked "Remote Control".



INFO:

If the DL2 data line supplied is not long enough, you can replace it with a commercially available network line that is longer or shorter (Category 5 patch cable).

5 Operation

5.1 Operation on the device

The integrated LEDs provide an overview of the operating status of the EFOY Pro fuel cell. You operate the device using the buttons.

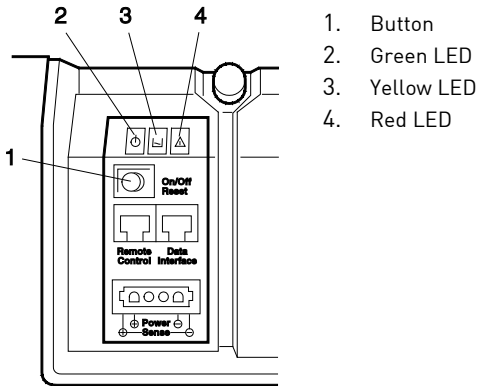

Button action	Result	Starting state	Resulting state
Push briefly (< 0.5s)	Reset	On, Off or Automatic	Automatic
Push longer (> 3s)	Switch On / Off	On or Automatic	Off
		Off	On

LED state	Green LED	Yellow LED	Red LED
On	Ready	Add service fluid	Error
Flashing	Shutting down	Fuel empty	Interruption
Off	Off or error	No error	No error

5.2 Operation via the operating panel

5.2.1 Buttons and symbols on the operating panel

Buttons/LEDs



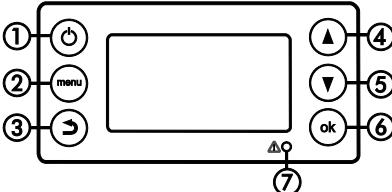







The buttons and LEDs on the operating panel have the following functions:



1.		Switch EFOY Pro fuel cell on/off
2.	[menu]	Display the main menu.
3.	[←]	Scroll back one level in the menu.
4.	[▲]	Scroll up one line in the display.
5.	[▼]	Scroll down one line in the display.
6.	[ok]	<ul style="list-style-type: none"> • Open the selected menu. • Confirm a selection.
7.		Red LED lights up to indicate a fault.

Symbols on the display

The display shows different symbols depending on the operating status and operating mode of the EFOY Pro fuel cell:

	Current battery voltage.
	Current charging current of the EFOY Pro fuel cell.
 	<p>Fill level of the fuel cartridge.</p> <p>INFO: The fuel gauge for the fuel cartridge is just an indicator and calculates the methanol consumption. The FS1 fuel cartridge sensor must be used to measure the actual fill level. The fuel cartridge should only be replaced once it has been completely emptied.</p>
	A cluster icon is displayed for EFOY Pro devices that run in parallel (see chapter 8.5 "Cluster controller CC1" on page 95).
	If want to operate the EFOY Pro fuel cell using an external controller, the external control function must be enabled (see chapter 5.5.4 "External control" on page 62). If this is not enabled, a padlock symbol appears.
	If the external control is switched on, an open padlock appears at the bottom right of the display (Factory defaults).
	If you have switched external control on and the device is in "Remote Control" mode, "RC" (Remote Control) appears at the bottom right of the display.
	If the battery type was changed via the expert menu to Lithium iron phosphate (LiFePO ₄), a LiFe-icon appears top right on the display (see chapter 5.2.5 "Expert menu" on page 44).
	The altitude was set above 1500 meter. An icon appears on the right on the display.

5.2.2 Initial commissioning

Switch on

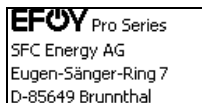

After connecting the EFOY Pro fuel cell to the operating panel for the first time, the intro screen appears on the display.

After a short wait, the language selection appears.

Selecting a language

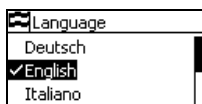

1. Use [▲] [▼] to select the required language.
2. Press [ok] to confirm your selection.



Selecting a fuel cartridge

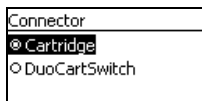

After connecting the operating panel for the first time and selecting the language, you are prompted to enable the installed fuel cartridge.

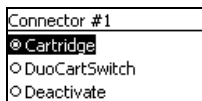

Depending on whether you are using an EFOY Pro or EFOY Pro Duo device, "Connector" or "Connector #1" is displayed.

1. Use [▲] [▼], to select whether you want to use a single fuel cartridge or a DuoCartSwitch for the relevant connector.
2. Press [ok] to confirm your selection.



INFO:

A detailed description of the DuoCartSwitch is available in the respective user manual.

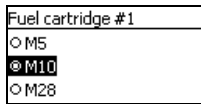

3. Select the relevant fuel cartridge for each connector.
4. Press [ok] to confirm your selection.

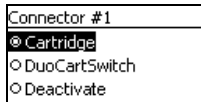

If you are using an EFOY Pro Duo fuel cell, "Connector #1" is displayed first. If you confirm this selection, you can select "Connector #2".

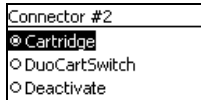

5. Press [ok] to confirm your selection.

5.2.3 Info screen

During subsequent operation of the device, an info screen appears after switching the device on.

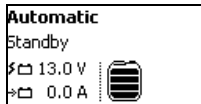

- Use  to access the operating mode.
- Press [menu] to access the main menu.
- Press [▼] to access the system information.

The first line indicates the operating mode selected, e.g., "Automatic" (see chapter 5.5 "Operating modes" on page 59).

The second line indicates the operating status (see "Operating status" on page 40).

The symbols at the bottom of the display indicate the battery charge condition and the fill level of the fuel cartridge (see "Symbols on the display" on page 37).

Operating mode

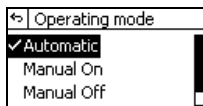

1. Press . The operating mode selection appears.
2. Use [▲] [▼] to select the operating mode (see chapter 5.5 „Operating modes“ on page 59).
3. Press [ok] to confirm your operating mode selection.

Operating status

Start phase	The EFOY Pro fuel cell undergoes a start phase lasting up to 20 minutes. At the end of this phase, it has reached its full rated output.
Charging mode	The EFOY Pro fuel cell charges the battery.
Standby	As long as the battery charge has a sufficient degree, the EFOY Pro fuel cell remains in standby mode and monitors the battery.
Shutdown procedure	The EFOY Pro fuel cell shuts down charging mode. To protect the components in the device, this procedure may take several minutes to complete.
Antifreeze	The EFOY Pro fuel cell remains active to protect itself from the effects of freezing. For more information, see chapter 5.6 "Automatic antifreeze feature" on page 66.
Battery protection	The EFOY Pro fuel cell charges the battery automatically in order to prevent deep discharge of the battery.
Interruption	Operation is interrupted because the ambient temperature is too high. The EFOY Pro fuel cell switches on again automatically as soon as operation can be resumed.

Error	An error has been detected, and corresponding messages are displayed. For more information, see chapter 7.2 "Errors and solutions" on page 73.
-------	--



INFO:

During normal operation, the EFOY Pro fuel cell briefly interrupts power generation several times each hour for max. 30 seconds. A charging current of 0.0 A is displayed when this occurs.

System information

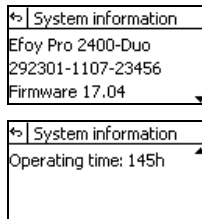

1. Press [▼]. The system information is displayed.
2. Press [▲][▼] to select the lower screen area.

The error messages are explained in chapter 7.2.1 "Error message on the display" on page 73.

5.2.4 Main menu

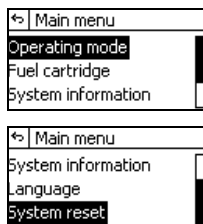

- Press [menu]. The main menu appears.
- Press [▲][▼] to select a submenu.
- Press [ok] to access the selected submenu.
- Press [↶] to return to the info screen.

You can select the following menu options in the main menu:

Operating mode

For a detailed description, see chapter 5.5 "Operating modes" on page 59.

Fuel cartridge

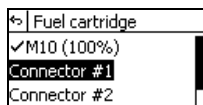

1. Select the connected fuel cartridge.
2. Press [ok] to confirm your selection.



INFO:

If you have not connected a full fuel cartridge, disable the fuel gauge by selecting "Disable fuel gauge" in the menu.

System information

For a detailed description, see "System information" on page 41.

Language

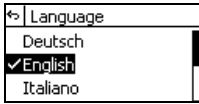

1. Press [▲] [▼] to select the language.
2. Press [ok] to confirm the language selection.



Reset

The reset function allows you to restart the EFOY Pro fuel cell:

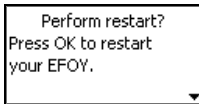

- Press [ok] to confirm the restart.
- Press [↵] to cancel the restart and return to the main menu.

5.2.5 Expert menu



CAUTION!

Incorrectly set operating parameters may damage the device. This may nullify your warranty.

Only use the precise values permitted for the battery parameters and battery protection settings (see page 50).

Before installation and operation please check the battery data sheets from the manufacturers permitted battery values.



- Press and hold [ok] and [menu] at the same time for 2 seconds. The expert menu appears.
- Press [▲] [▼] to select a submenu.
- Press [ok] to access the selected submenu.
- Press [↶] to return to the expert menu.

You can select the following menu options in the expert menu:

- Battery type
- Battery parameters
- Battery protection
- Communication
- Factory defaults

This option allows you to undo all the settings in the menu "Expert menu". Press [ok] to confirm or [↶] to cancel.

Battery type

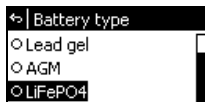
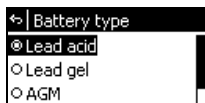

You can select the following batteries in the "Battery type" menu:

- Lead-acid
- Lead gel
- AGM
- LiFePO4 (Lithium iron phosphate)

Press [ok] to access to select a battery type.

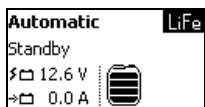

By choosing the LiFePO4 battery type, the Icon "LiFe" will be shown on the Info screen.



CAUTION!

Incorrectly set battery type may damage the battery. This may nullify your warranty.

Only use the precise values permitted for the battery parameters and battery protection settings on page 50.



INFO:

The factory defaults for all battery types are based on experience and the parameters for the LiFePO4 batteries are tested and approved only with specific batteries. Please refer to your dealer or follow the advice of the battery manufacturer.

Battery parameters

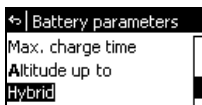
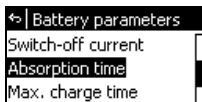
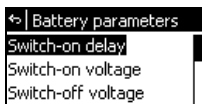

You can select the following options in the "Battery parameters" menu:

- Switch-on delay
- Switch-on voltage
- Switch-off voltage
- Switch-off current
- Absorption time
- Max. charge time
- Altitude up to
- Hybrid
- Factory defaults



CAUTION!

Incorrectly set operating parameters may damage the device. This may nullify your warranty.

Only use the precise values permitted for the battery parameters and battery protection settings (see page 50).



CAUTION!

Adjust the battery settings according to the application.

Check the battery specific characteristic curve to set the battery parameters fitting to the discharge values.

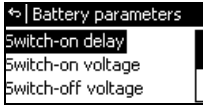
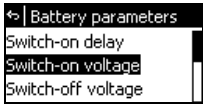
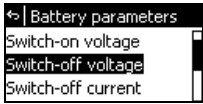
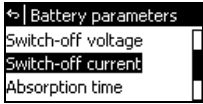
Battery parameters	Function
<p>Switch-on delay</p> 	<p>The EFOY Pro fuel cell does not start immediately if the switch-on voltage only drops below the set threshold level temporarily. The device only starts automatically if the switch-on voltage is still below this threshold level after the switch-on delay of 60 seconds. For example, with the factory default of 12.3 V for lead-acid batteries, the switch-on voltage must drop below 12.3 V for at least 60 seconds in order for the EFOY Pro fuel cell to start.</p> <p>If loads with a high rate of power consumption are operated temporarily, this value must be set in accordance with the operating times of these loads.</p>
<p>Switch-on voltage</p> 	<p>The EFOY Pro fuel cell switches on at the set voltage and charges the battery.</p> <p>Setting too high a value for the switch-on voltage results in frequent starting of the EFOY Pro fuel cell. Setting too low a value for the switch-on voltage results in damage to the battery. The default value for lead batteries is 12.3 V, which corresponds to approx. 50% of the battery charge condition.</p>
<p>Switch-off voltage</p> 	<p>If the battery voltage reaches the set level, the EFOY Pro fuel cell switches off, provided that the value set for the "Switch-off current" parameter has also been reached.</p> <p>Please note your battery's end-of-charging voltage. Note the charging recommendations provided by the battery manufacturer.</p>
<p>Switch-off current</p> 	<p>The EFOY Pro fuel cell switches off if the current drops below the set switch-off current.</p> <p>If you want the battery voltage to serve as the only switch-off parameter, set the maximum value, as the current is always below this value in EFOY Pro fuel cells.</p>

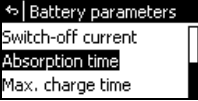
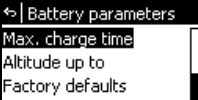
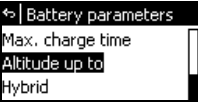
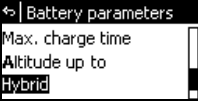
Battery parameters	Function
<p>Absorption time</p> 	<p>This function serves as an additional switch-off criterion for EFOY Pro fuel cells if the switch-off current level is not reached within the set time period.</p> <p>This period is set by default to 3 hours, but can be changed to any value between 0 and 5 hours.</p>
<p>Max. charge time</p> 	<p>If the switch-off criteria, voltage and current, have not been satisfied, the EFOY unit will shut down after defined operating hours. Once the switch-on criteria have been satisfied, the EFOY unit will turn on again, which can be immediately after the maximum charge time.</p> <p>This switch-off criterion prevents unlimited charge cycles caused by various factors like defective batteries.</p>
<p>Altitude up to</p> 	<p>The EFOY Pro fuel cell is set by default for a use up to an altitude of 1500 meter. For use at a higher altitude for a longer period, we recommend to increase the value.</p>
<p>Hybrid (Switch-off voltage)</p> 	<p>Only in Hybrid mode. If the battery voltage reaches the set level, the EFOY Pro fuel cell switches off, provided that the value set for the "Switch-off current" parameter has also been reached.</p>



INFO:

The EFOY Pro fuel cell switches off automatically. This fully-automatic switch-off function is controlled by the two operating parameters of battery voltage and charging current. In order for the EFOY Pro fuel cell to switch off, the voltage must rise above the set switch-off voltage level, and the current must drop below the set switch-off current. The factory defaults for lead batteries are a switch-off voltage of 14.2 V / 28.4 V and a switch-off current of 2.0 A / 4.0 A. This means that the EFOY Pro fuel cell switches off as soon as the battery reaches a voltage of 14.2 V / 28.4 V and the charging current simultaneously drops below 2.0 A / 4.0 A.

Permitted value ranges for lead batteries (12 V)					
	ID	Factory defaults	Min.	Max.	User-defined value:
Switch-on voltage	18	12.3 V	11.0 V	13.0 V	
Switch-off voltage	19	14.2 V	13.5 V	14.7 V	
Switch-off voltage (Hybrid)	74	14.7 V	13.5 V	15.5 V	
Switch-off current	20				
EFOY Pro 800		2.0 A	1.0 A	10.0 A	
EFOY Pro 2400		4.0 A	2.0 A	10.0 A	
Switch-on delay	17	60 s	2 s	300 s	
Absorption time	45	180 min	0 min	300 min	
Max. charge time	49	24 h	2 h	120 h	
Altitude up to	24	1500 m	0 m	2000 m	
Permitted value ranges for lead batteries (24 V)					
	ID	Factory defaults	Min.	Max.	User-defined value:
Switch-on voltage	21	24.6 V	22.0 V	26.0 V	
Switch-off voltage	22	28.4 V	27.0 V	29.4 V	
Switch-off voltage (Hybrid)	75	29.4 V	27.0 V	31.0 V	
Switch-off current	23				
EFOY Pro 800		1.0 A	0.5 A	5.0 A	
EFOY Pro 2400		2.0 A	1.0 A	5.0 A	
Switch-on delay	17	60 s	2 s	300 s	
Absorption time	45	180 min	0 min	300 min	
Max. charge time	49	24 h	2 h	120 h	
Altitude up to	24	1500 m	0 m	2000 m	

Permitted value ranges for LiFeP04 batteries (12 V)					
	ID	Factory defaults	Min.	Max.	User-defined value:
Switch-on voltage	25	12.6 V	12.0 V	13.4 V	
Switch-off voltage	26	14.5 V	13.8 V	14.6 V	
Switch-off voltage (Hybrid)	76	14.6 V	13.5 V	15.5 V	
Switch-off current	27				
EFOY Pro 800		2.0 A	0.5 A	10.0 A	
EFOY Pro 2400		4.0 A	2.0 A	10.0 A	
Switch-on delay	17	60 s	2 s	300 s	
Absorption time	45	180 min	0 min	300 min	
Max. charge time	77	48 h	2 h	120 h	
Altitude up to	24	1500 m	0 m	2000 m	
Permitted value ranges for LiFeP04 batteries (24 V)					
	ID	Factory defaults	Min.	Max.	User-defined value:
Switch-on voltage	78	25.2 V	24.0 V	26.8 V	
Switch-off voltage	79	29.0 V	27.6 V	29.2 V	
Switch-off voltage (Hybrid)	82	29.0 V	27.6 V	31.0 V	
Switch-off current	80				
EFOY Pro 800		1.0 A	0.5 A	5.0 A	
EFOY Pro 2400		2.0 A	2.0 A	5.0 A	
Switch-on delay	17	60 s	2 s	300 s	
Absorption time	45	180 min	0 min	300 min	
Max. charge time	77	48 h	2 h	120 h	
Altitude up to	24	1500 m	0 m	2000 m	

Battery protection



CAUTION!

Incorrectly set operating parameters may damage the device. This may nullify your warranty.

Only use the precise values permitted for the battery parameters and battery protection settings (see page 50).

The EFOY Pro fuel cell has automatic battery protection when the EFOY Pro fuel cell is switched off.

Battery protection is enabled automatically if the battery voltage (Lead-batteries) drops below 11.2 V / 22.4 V for more than 60 seconds. "Battery protection" mode ends as soon as the voltage reaches 12.8 V / 25.6 V.

The battery protection function provides deep discharge protection for the battery, even when the EFOY Pro fuel cell is switched off and does not take over the charging function.

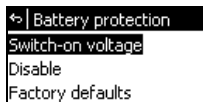

You can select the following menu options in the "Battery protection" menu:

- Switch-on voltage
- Enable/Disable
- Factory defaults

This option allows you to undo all the battery protection settings. Press [ok] to confirm or [↵] to cancel.

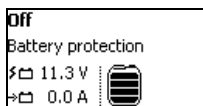

If you want to switch off the EFOY Pro fuel cell after the battery protection function has started, press . The function is re-enabled automatically when the device is switched on or is operated in automatic mode.

	ID	Factory defaults	Min.	Max.	User-defined value:
Permitted value ranges for Lead-acid, -gel & AGM batteries					
Battery protection (12 V)	46	11.2 V	10.5 V	12.0 V	
Battery protection (24 V)	47	22.4 V	21.0 V	24.0 V	
Permitted value ranges for LiFePO4 batteries					
Battery protection (12 V)	48	11.0 V	10.5 V	12.5 V	
Battery protection (24 V)	81	22.0 V	21.0 V	25.0 V	



INFO:

Please check your system if the fuel cell repeatedly switches back to battery protection. Either the battery has already been damaged or too much energy has been discharged.



INFO:

Battery protection only works if a full EFOY fuel cartridge is connected.

Communication

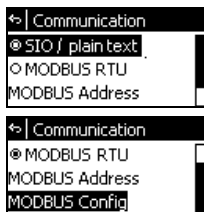

In the menu “Communication” different communication protocols can be selected.

- SIO / plain text (Factory setting)
- MODBUS RTU

Furthermore two menus for MODBUS settings are available:

- o MODBUS Address
- o MODBUS Config

A detailed description is available in this user manual in chapter 8.2 „Communication Protocols“ on page 81.

Factory defaults

This option allows you to undo all the settings made in the expert menu. Press [ok] to confirm or [↵] to cancel.

5.3 Remote control via computer

You can also control the EFOY Pro using a computer. Remote control is also possible using an optional modem.

The same operating functions available via the operating panel are also available via the data interface (see chapter 5.2 “Operation via the operating panel” on page 36).

A detailed description is available in the user manual for the interface adapter.

5.4 Fuel cartridges

5.4.1 Connecting the fuel cartridge

Fuel cartridge empty
Please replace the fuel cartridge, and press OK.

When the fuel cartridge is empty, the yellow LED on the device flashes and the red LED on the operating panel. "Fuel cartridge empty" also appears on the operating panel.

The fuel cartridge can be changed while the device is in operation.

EFOY fuel cartridges are intended for single use only and cannot be re-filled.



WARNING!

Use only original EFOY fuel cartridges!

Please refer to the information about methanol provided in chapter 2 "Safety Information" on page 5.



Keep all EFOY Pro fuel cells and EFOY fuel cartridges out of reach of children, even when empty or only partly full.

Inserting the fuel cartridge

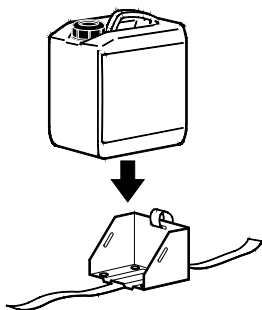

1. Insert a new, full, and sealed original EFOY fuel cartridge into the fuel cartridge holder.



INFO:

Always place the fuel cartridge in the fuel cartridge holder with the connector facing upwards.
Exception: M28 fuel cartridge (see "Connecting the M28 fuel cartridge" on page 56).

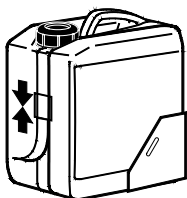

2. Fasten the belt on the fuel cartridge holder.

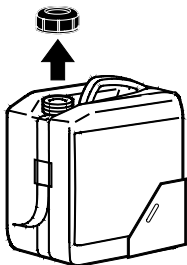

3. Do not remove the child-proof screw cap until the new EFOY fuel cartridge has been inserted into the fuel cartridge holder.



INFO:

Store the screw cap.

4. Screw the fuel cartridge connector onto the new EFOY fuel cartridge.
5. Press [ok] on the operating panel so that the red warning light and error message are no longer displayed.

6. Select the installed fuel cartridge on the operating panel (see chapter 5.4.2 "Selecting a fuel cartridge" on page 57).

Connecting the M28 fuel cartridge

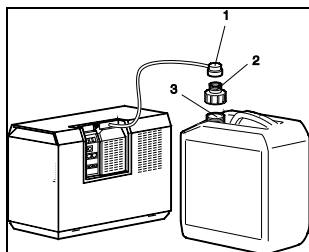

1. Screw the EFOY Pro fuel cartridge connector (1) to the M28 adapter (2).
2. Screw the M28 adapter (2) onto the M28 fuel cartridge (3).



INFO:

The M28 fuel cartridge can only be connected using the optional M28 adapter.

For use in vehicles an appropriate fastening has to be used. The installation as well as the safety related inspection has to be done by the user.

The M28 fuel cartridge may also be used on its side. The valve must be on the side at the top for this.

Removing the fuel cartridge

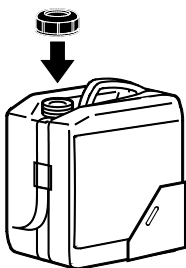

1. Unscrew the fuel cartridge connector from the empty EFOY fuel cartridge.
2. Open the belt.
3. Remove the empty EFOY fuel cartridge.
4. Use the screw cap to seal each EFOY fuel cartridge securely after use.

5.4.2 Selecting a fuel cartridge

When you select the "Fuel cartridge" submenu in the main menu, the display shows the fuel cartridges already enabled and the device connectors.

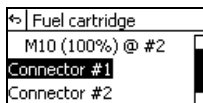
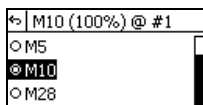
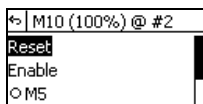
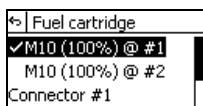
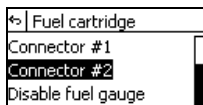
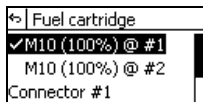

The connectors are displayed according to whether you are using an EFOY Pro or EFOY Pro Duo device.



INFO:

If you have not connected a full fuel cartridge, disable the fuel gauge by selecting "Disable fuel gauge" in the menu.

1. Select an active fuel cartridge to edit it directly.
2. Press [ok] to confirm your selection.

You can select the following actions in the fuel cartridge submenu:

- Reset:
Resets the counter after the fuel cartridge has been changed.
- Enable:
Enables the fuel cartridge.
- M5 / M10 / M28:
Changes the fuel cartridge type for the respective connector.

3. Select a connector to edit the connector and any associated fuel cartridges.
4. Press [ok] to confirm your selection.

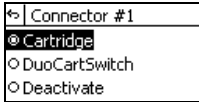

You can select the following actions in the connect-
or submenu:

- Cartridge:
A single fuel cartridge is to be used at the connector. The associated fuel cartridge is displayed at the highest level of the menu.
- DuoCartSwitch:
A DuoCartSwitch is to be used at the connector.
A detailed description of the DuoCartSwitch is available in the respective user manual.
- Deactivate:
Disables the connector.

5.5 Operating modes

The EFOY Pro fuel cell can be operated in one of the following modes:

- Automatic
- Manual On
- Manual Off
- External control
- Hybrid

5.5.1 Automatic

Automatic mode starts as soon as you connect the device to the battery. The device monitors the battery voltage independently.

The EFOY Pro fuel cell switches on automatically if the battery voltage drops below 12.3 V / 24.6 V (Lead batteries). The battery is then charged until the cut-off threshold of 14.2 V / 28.4 V is reached.

When the device is started, it goes through a start phase, which may last up to 20 minutes. It only reaches its full rated output after this phase.

During normal operation, the EFOY Pro fuel cell briefly interrupts power generation several times each hour. A charging current of 0.0 A is displayed when this occurs. This interruption lasts around 20 seconds.



INFO:

If the device fails to start, check that the cap is not still attached to the exhaust hose connector. Remove the cap.



INFO:

To ensure optimal battery maintenance, the charging current must not be stopped abruptly when the cut-off threshold is reached. For this reason, the EFOY Pro fuel cell continues charging the battery for up to three hours at a reduced current after the configured cut-off threshold is reached (factory default lead batteries: 14.2 V / 28.4 V). The length of the recharging period depends on the battery voltage and power consumption.

5.5.2 Manual On

You can switch the device on manually if the battery voltage is below 13.2 V / 26.4 V (Lead batteries). After the start phase, the device is then in "charging mode".

The device operates independently of the configured switch-on voltage, and charges the battery until the cut-off threshold is reached.

($U_{\text{batt}} > 14.2 \text{ V} / 28.4 \text{ V}$ and $I_{\text{off}} < 2.0 \text{ A} / 4.0 \text{ A}$)

After reaching the switch-off threshold the EFOY Pro fuel cell will switch into automatic mode.

Please note: The EFOY Pro fuel cell can only start if it is connected to an intact battery and a filled fuel cartridge. The EFOY Pro fuel cell does not switch on if the battery is damaged or has been deeply discharged.



INFO:

If the device fails to start, check that the cover lid is not still attached to the exhaust hose connector. Remove the cover lid.

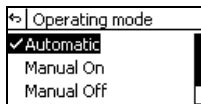

1. Press  on the operating panel, or select "Operating mode" in the main menu. The operating mode selection appears.
2. Select the "Manual On" operating mode.
3. Press [ok] to confirm your selection.

5.5.3 Manual Off



INFO:

To protect the components, the device should not be switched off until it has been running for at least 30 minutes since it was started. If the device is switched off before this period has elapsed, it will continue running for the remainder of the required running time. The message "Shutdown procedure" is shown on the display. Do not disconnect the fuel cartridge or battery during the shutdown procedure.



INFO:

The battery protection and automatic antifreeze functions remain active after the device is switched off.

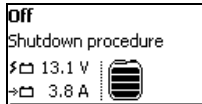
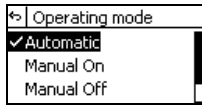



1. Press on the operating panel, or select "Operating mode" in the main menu. The operating mode selection appears.
2. Select the "Manual Off" operating mode.
3. Press [ok] to confirm your selection.
4. Wait until the shutdown procedure has finished and "Shutdown procedure" is no longer displayed on the info screen.

The EFOY Pro fuel cell shuts down in a controlled manner when you press [ok]. This may take some time, to ensure that all protective features are applied.

5.5.4 External control

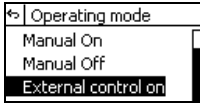
The EFOY Pro fuel cell can also be controlled externally. In that case, the automatic charge control mechanism will be partly or totally deactivated. For an external control the operation mode "External control" must be enabled.



1. Press  on the operating panel, or select "Operating mode" in the main menu. The operating mode selection appears.
2. Select the "External control on" operating mode.
3. Press [ok] to confirm your selection.

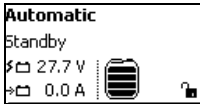

An open padlock is displayed at the bottom right of the display.

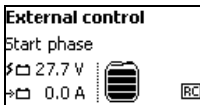

If the controller now receives an external signal, e.g. on Pin 7 (Data Interface), "RC" (Remote Control) is displayed at the bottom right of the display.

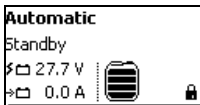

INFO:

If you have not enabled external control, a closed padlock is displayed at the bottom right of the display when an external signal is being received.



CAUTION!

Incorrectly set operating parameters may damage the device. This may nullify your warranty.

Only use the precise values permitted for the battery parameters and battery protection settings.

5.5.5 Remote On / Off

The EFOY Pro fuel cell can be switched on or off externally using one of two methods. One option is by using a switching contact on Pin 7 at the Data Interface plug, e.g. a solar charger. The second option is a software signal. See chapter 3.2 Connections on page 14 for the pinning.

The "External control" operating mode must be enabled (see chapter 5.5.4 External control, page 62).

1) Remote on/off signal via Pin 7 (Data interface)

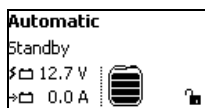

An open padlock is displayed at the bottom right of the display.

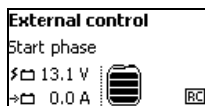

If the EFOY Pro receives an external positive voltage signal on Pin 7, "RC" (Remote Control) is displayed at the bottom right of the display. The EFOY Pro will start charging, regardless of the switch-on voltage and will charge the batteries until the set switch-off parameters are reached.

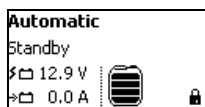

INFO:

If you have not enabled external control, a closed padlock is displayed at the bottom right of the display when an external signal is being received.

If the external signal on Pin 7 is always active, the EFOY Pro will start when the battery voltage is below 13.2 V / 26.4 V (Lead batteries) or 14.0 V / 28.0 V (LiFePO4) and stop when the switch-off voltage is reached. The charging will start again at 13.2 V / 26.4 V (Lead batteries) or 14.0 V / 28.0 V (LiFePO4). The EFOY Pro will not stop charging in this operation until removing the external signal on Pin 7.

If the external signal is removed (off), the EFOY Pro will charge the battery until the set switch-off parameters are reached and switch back in automatic mode.

2) Remote on/off signal via software command

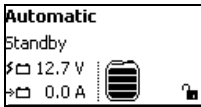

An open padlock is displayed at the bottom right of the display.

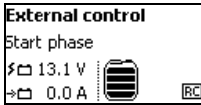

If the EFOY receives a software signal via SIO command REMOTE ON or via Modbus address 41030, "RC" (Remote Control) is displayed at the bottom right of the display. The EFOY Pro will start charging, regardless of the switch-on voltage and charge the batteries until the set switch-off parameters are reached.

The signal only has to be sent once. The EFOY Pro will complete a charging cycle and switch off if the set switch-off parameters have been reached.

After the charging cycle the EFOY Pro will switch again into automatic mode.

In the case of a software command, the charging cycle can be stopped by sending the SIO command REMOTE OFF or via Modbus address 41030.

5.5.6 Hybrid

The EFOY Pro can be set into Hybrid mode by a voltage signal or a software control. In this operation mode all parameters are disabled, like switch-on voltage or battery protection. Only the frost protection mode is an exception, this will remain enabled.

The "External control" operating mode must be enabled (see chapter 5.5.4 External control, page 62).

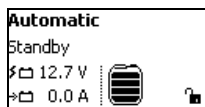

The hybrid mode must be separately activated.

Activation via voltage signal:

Connect Pin 4 (GND, Ground) or the negative battery pole with Pin 8 (Hybrid)

Activation via software control:

Send at least every 15 seconds the SIO command HYBRID or Modbus address 42002 Hybrid to the EFOY Pro fuel cell.

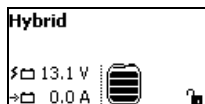

The operation mode "Hybrid" will be displayed and the open padlock will be displayed at the bottom right of the display.

To start and stop the EFOY Pro fuel cell a positive voltage signal must be connected to Pin 7 (Remote On) or via software SIO command REMOTE ON/OFF or Modbus address 41030 (see chapter 5.5.5 Remote On / Off, page 63).

The battery voltage will not exceed the set value switch-off voltage (Hybrid). If the voltage signal on pin 7 or the "Remote ON" software commands is continuous, the EFOY Pro fuel cell will charge the battery continuously in full and part load mode as a constant voltage (CV) charger.

5.6 Automatic antifreeze feature

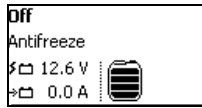

The device has an intelligent automatic antifreeze feature. This operating status switches on automatically as soon as the temperature drops below +3 °C / +37.4 °F. This prevents the device from freezing. If the device is operating in antifreeze mode, the message "Antifreeze" is shown in the second line of the display.



CAUTION!

The automatic antifreeze feature only works when the fuel cell is connected to a filled EFOY fuel cartridge and an intact battery.

For a five-month winter period in Central Europe, the device requires approx. 10 liters / 2.64 gallons of methanol in antifreeze mode.

5.7 Shutdown

5.7.1 Switching off the fuel cell

Switch off the EFOY Pro fuel cell via the operating panel or directly on the device. This is described in chapter 5.5.3 "Manual Off" on page 61, or in chapter 5.1 "Operation on the device" on page 35.



INFO:

The message "Shutdown procedure" is shown on the display. Do not disconnect the fuel cartridge or battery during the shutdown procedure.

5.7.2 Detaching the charge line and data line

Disconnect the charge line and data line for the operating panel from the EFOY Pro fuel cell.



INFO:

Store the plugs and cables in a cool, dry place.

5.7.3 Removing the EFOY fuel cartridge

This is described in "Removing the fuel cartridge" on page 55.



INFO:

Protect the fuel cartridge and the fuel cartridge connector on the device from impurities.

5.7.4 Detaching the exhaust hose and off-heat tube

1. Disconnect the exhaust hose. Protect it from impurities and seal the exhaust outlet with the protective cap.
2. Remove the off-heat tube or the off-heat bow, if necessary, and release the EFOY Pro fuel cell from the mounting plate.

**CAUTION!**

Store the EFOY Pro fuel cell in a cool place, but at a temperature over +1 °C / +34 °F. (See also storage temperature in chapter 3.3 "Specifications" on page 16).

If the EFOY Pro fuel cell is exposed to temperatures below 0 °C / 32 °F without connected batteries and sufficiently filled fuel cartridges, it must be defrosted for approximately 24 hours at room temperature before use.

**INFO:**

Use a suitable box for storing the EFOY Pro fuel cell, e.g., the box in which it was delivered. The EFOY Pro fuel cell must be stored in an upright position only.

6 Maintenance

6.1 Service

Under normal operating conditions, the EFOY Pro fuel cell is maintenance-free.

**WARNING!**

Do not open the EFOY Pro fuel cell! Unauthorized opening of the EFOY Pro fuel cell interferes with safe operation of the device and nullifies the warranty and guarantee. The EFOY Pro fuel cell does not contain any parts that you can maintain or repair yourself.

6.2 Long term storage

**CAUTION!**

Store the EFOY Pro fuel cell in a cool place, but at a temperature over +1 °C / +34 °F. (See also storage temperature in chapter 3.3 "Specifications" on page 16).

If the EFOY Pro fuel cell is exposed to temperatures below 0 °C / 32 °F without connected batteries and sufficiently filled fuel cartridges, it must be defrosted for approximately 24 hours at room temperature before use.

After long term storage over 6 month SFC recommends to check the functionality of the EFOY Pro fuel cell before installation. For that purpose connect the fuel cell to a battery to run a charging cycle. A charging cycle can last several hours. After successfully passing the charging cycle run the transport lock procedure. Press the [menu] and [▼] button on the Operating panel at least 3 seconds and follow the instructions on the display.

**CAUTION!**

Note that liquid can drop out of the exhaust hose tube when running the transport lock procedure.

**INFO:**

Use a suitable box for storing the EFOY Pro fuel cell, e.g., the box in which it was delivered. The EFOY Pro fuel cell must be stored in an upright position only.

6.3 Firmware update

Be sure to check on a regular basis which updates are available for your firmware.

Simply connect the EFOY Updater to your EFOY Pro fuel cell to perform the update.

For information on the latest firmware updates and the Updater, please contact your service partner or go to www.efoy-pro.com.

Freecall: 00800 732 762 78*

Hotline: +49 89 673 592 555

service@sfc.com

*Calls can be placed free of charge from the landline from: Germany, Belgium, Denmark, France, Great Britain, Italy, the Netherlands, Norway, Austria, Sweden, Switzerland and Spain.

6.4 Cleaning



WARNING!

Switch the device off and disconnect the charge line before cleaning.

The device is not water-tight. Please ensure that no moisture can enter the device.

1. Clean only with a soft cloth dampened with a mild detergent.
2. Reconnect the battery charge line after cleaning so that the automatic antifreeze feature remains activated (see chapter 5.6 "Automatic antifreeze feature" on page 66).

7 Troubleshooting

7.1 Safety

**WARNING!**

Do not open the EFOY Pro fuel cell! Unauthorized opening of the EFOY Pro fuel cell interferes with safe operation of the device and nullifies the warranty and guarantee. The EFOY Pro fuel cell does not contain any parts that you can maintain or repair yourself.

If you cannot resolve an error using these instructions, please contact the sales partner from whom you purchased the device, or contact our service hotline directly.

Contact details

Headquarters

SFC Energy AG

Eugen-Saenger-Ring 7

85649 Brunnthal

Germany

Hotline: +49 89 / 673 592 555

Freecall: 00800 / 732 762 78*

eMail: service@sfc.com

Web: www.efoy-pro.com

*Calls can be placed free of charge from the landline from: Germany, Belgium, Denmark, France, Great Britain, Italy, the Netherlands, Norway, Austria, Sweden, Switzerland and Spain.

7.2 Errors and solutions

7.2.1 Error message on the display

In the event of interruptions and errors, the operating panel displays warning messages on the display panel, including an error code and instructions on how to resolve the error.

By following these instructions, you can quickly and easily eliminate some of the errors that may occur.

Error message on the display	Error code	Solution
Service is required. Protect device against frost! Please contact EFOY hotline or hotline@sfc.com .	1 10 15 31 76 83	Please contact your service partner or the hotline. Contact details are provided in chapter 1.2 "Contact details" on page 4.
A restart is required. If the error occurs again please contact EFOY hotline or hotline@sfc.com . Press OK for restart.	13 14 17 70 73 75 80 84	Select the "System reset" option in the main menu to restart the device (max. twice). If the error still occurs, please contact your service partner or the hotline. Contact details are provided in chapter 1.2 "Contact details" on page 4.
Please make sure the exhaust hose is not blocked, bent or frozen. Press OK for restart.	11 18	Please check the installation of the exhaust hose and position it so that no condensation can gather. Do not bend the exhaust hose. If necessary, clean the exhaust hose and protect the opening from becoming clogged. Shorten the exhaust hose if condensation is gathering in it.

Error message on the display	Error code	Solution
Fuel cartridge empty. Please replace the fuel cartridge, and press OK.	20 22	See chapter 5.4 "Fuel cartridges" on page 54.
Please refill service fluid Press OK for restart.	30	Make sure that the off-heat can escape without obstruction and that the ambient temperature is below 50 °C / 122 °F. If the fuel cell is installed within a sealed container, please ensure that the opening for supply air has a cross-section of at least 10 cm / 3.94 in. Then refill the fuel cell with EFOY service fluid (see chapter 7.3 "Adding EFOY service fluid" on page 77).
Interruption: Cooling insufficient. Please check installation and air supply!	32	The cooling air is insufficient or the ambient air is too warm. Please check whether the room in which the fuel cell is installed has sufficient ventilation, or whether the openings for the air supply in the EFOY Pro fuel cell are blocked.
Interruption: Device frozen. Please defrost device slowly for at least 24h at room temperature.	40	The device was exposed to temperatures below 1°C / 34°F without a connected battery and/or an EFOY fuel cartridge that was not filled sufficiently. It must be allowed to defrost for approx. 24 hours at room temperature.
Interruption: Surroundings too warm. Please wait for the device to cool down.	41	The ambient temperature is too high. The device will start automatically if the temperature drops to below 50 °C / 122 °F.

Error message on the display	Error code	Solution
<p>Battery voltage low. Please check battery connection and load battery.</p>	<p>50 52</p>	<p>Please check the cabling and check whether a suitable battery is connected. Check the battery voltage. If it is too low, please load the battery with a battery charger. Please also check other loading devices for defects, e.g. alternator or charge controller.</p>
<p>Battery voltage high. If applicable, please check additional charging devices.</p>	<p>51 53</p>	<p>Please check the cabling and check whether a suitable battery is connected. Please also check other loading devices for defects, e.g. alternator or charge controller.</p>
<p>Please disconnect fuel cartridge connection, shake cartridge firmly and reconnect. Restart device at most 2 times. Press OK for restart.</p>	<p>72</p>	<p>Check the fuel cartridge connection and, if necessary, check for any contamination and remove it. Then please perform a system reset (max. twice). If the error still occurs, please contact your service partner or the hotline. Contact details are provided in chapter 1.2 "Contact details" on page 4.</p>

7.2.2 Errors without display messages

Possible cause	Solution
The operating panel is not connected or is not properly connected.	Check the connection to the operating panel (see chapter 4.7 "Installing and connecting the operating panel" on page 33).
No battery is connected, the battery has not been properly connected, or a deep discharge has occurred.	Check the pins, polarity and cables (see chapter 4.6 "Electrical connections" on page 28). Connect a charged battery in order to start the device.
Short-circuit has occurred.	Ensure that the polarity of the charge line is correct. Switch off the device, check the cause of the short circuit or overload, and eliminate the error.
If the problem recurs:	Please contact your service partner or the hotline. Freecall: 00800 / 732 762 78* Hotline: +49 89 / 673 592 555 service@sfc.com www.efoy-pro.com

*Calls can be placed free of charge from the landline from: Germany, Belgium, Denmark, France, Great Britain, Italy, the Netherlands, Norway, Austria, Sweden, Switzerland and Spain.

7.3 Adding EFOY service fluid

If the EFOY service fluid level is low, the yellow LED on the EFOY Pro fuel cell comes on and the message "Please refill service fluid" appears on the operating panel display.



WARNING!

If this message is displayed frequently, check that the air supply at the installation location is sufficient. There is no need to add EFOY service fluid under normal operating conditions.

Never refill the fuel cell with more than one bottle of EFOY service fluid at a time.

Use original EFOY service fluid only.

Switch off the EFOY Pro fuel cell before refilling with EFOY service fluid. Disconnect the charge line.

Make sure that no dirt or foreign bodies enter the fill opening.

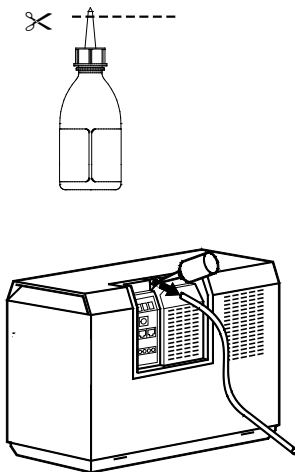

1. Use a clean pair of scissors to cut off the tip of the bottle.



INFO:

The EFOY service fluid bottle is for one time use only.

2. Disconnect the exhaust hose from the device.
3. Insert the tip of the bottle into the connection nozzle on the device and slowly squeeze the entire contents into the opening.
4. Use a cloth to wipe away any excess EFOY service fluid that may spill over.

5. Reattach the exhaust hose.
6. Reconnect the charge line to the EFOY Pro fuel cell.
7. When you have finished filling the device, press [ok].
The message is deleted and the EFOY Pro fuel cell returns to its previous operating status, e.g. automatic mode.
8. Be sure to order your next refill of EFOY service fluid from your specialist dealer in plenty of time.

8 Data Interface and Optional Accessories

8.1 Data interface functionality

The EFOY Pro data interface enables the connection of:

- Computer or modem with the interface adapter IA1
- Fuel cartridge sensor FS1
- Cluster controller CC1
- DuoCartSwitch DCS1



CAUTION!

The data interface cannot be connected directly to a computer. The interface adapter is required for this.

Connecting the EFOY Pro fuel cell directly to a computer can damage both devices.

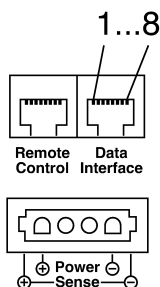

Pin	Data Interface
1	DuoCartSwitch DCS1
2	RS232 RxD (Recive Data)
3	RS232 TxD (Transmit Data)
4	GND, Ground
5	Battery +
6	Fuel Cartridge Sensor FS1
7	Remote On
8	Parallel/hybrid operation control

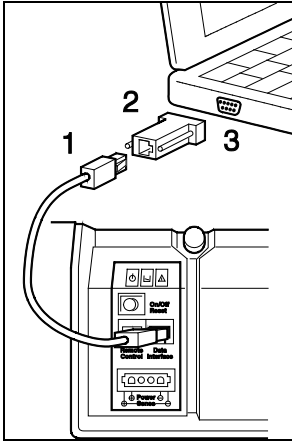

1. Data line
2. Interface adapter
3. PC (COM interface)

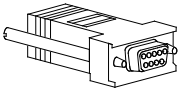

The interface adapter IA1 is used to connect the EFOY Pro to a computer or modem via the COM connection.

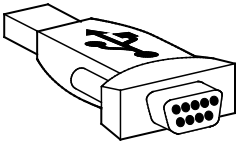

The USB adapter enables you to connect the interface adapter to the USB connection if no COM connection is available.

A detailed description is available in the user manual for the interface adapter.

8.2 Communication Protocols

The communication with the EFOY Pro fuel cells is possible via the serial RS-232 data interface. Also a direct modem connection for external control and observation is possible.

The operation state can be read, operation parameters can be changed or an external control can be implemented.

Following protocols are supported:

- SIO / clear text (factory settings)
- MODBUS RTU

The settings can be changed via the Operating panel OP2:

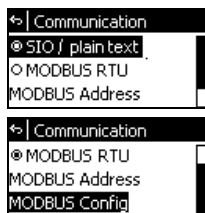

1. Press and hold [ok] and [menu] at the same time for 2 seconds. The expert menu appears.
2. Press [▼] to select a submenu “Communication” and press [ok] to access.
3. Press [▲] [▼] to select one of the following communication protocols:
 - o SIO / plain text
 - o MODBUS RTU
4. Select the required communication protocol for the RS-232 interface and press [ok] to select.

8.2.1 Modbus RTU

The EFOY Pro fuel cell enables a MODBUS RTU communication via the RS-232 data interface.

Following parameters are set for the MODBUS RTU protocol:

Baud rate: 9600

Data bits: 8

Parity: Even Parity

Stop bits: 1

Display in Operating panel OP2: 9600 8,E,1

The parameters can be changed on demand via Operating panel OP2, PC or Laptop.

Via Operating panel OP2:

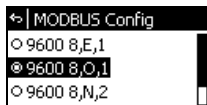

1. Press and hold [ok] and [menu] at the same time for 2 seconds. The expert menu appears.
2. Press [▼] to select a submenu “Communication” and press [ok] to access.
3. Select a submenu “MODBUS Config” and press [ok].
4. Press [▲] [▼] to select one of the following MODBUS configurations. Press [ok] to confirm.

Following configurations are available:

Display in Operating panel OP2	9600 8,E,1 (Standard)	9600 8,0,1	9600 8,N, 2	9600 8,N,1
Baud rate	9600	9600	9600	9600
Data bits	8	8	8	8
Parity	Even Parity	Odd Parity	No Parity	No Parity
Stop bits	1	1	2	1

Via PC or Laptop:

With the SIO command “MODBUS” the configurations can be adjusted as well as the MODBUS RTU protocol can be activated.

A detailed description is available in the user manual for the interface adapter.

Connection to a RS-485 network

An RS-485 interface is provided by the optional available EFOY Modbus Adapter. With this adapter an RS 485 network implementation can be realized.



INFO:

The pre-installed MODBUS Address is the last 2 numbers of the serial number.

For example the EFOY Pro with serial number 123456-1234-56789 has the MODBUS address 89. In the case where the serial number ends with 00 the address 100 is set.

The MODBUS address of each EFOY Pro fuel cell can be changed via the Operating panel OP2 or with the MODBUS command:



CAUTION!

Wrong set addresses can cause conflicts within the communication network!

Make sure that every MODBUS address in an RS-485 network is only given once. If one address is given to several components the network can be disturbed.

Via Operating panel OP2:

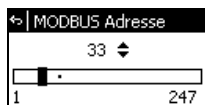

1. Press and hold [ok] and [menu] at the same time for 2 seconds. The expert menu appears.
2. Press [▼] to select a submenu "Communication" and press [ok] to access.
3. Select a submenu "MODBUS Address" and press [ok].
4. Press [▲][▼] to select a MODBUS address between 1 and 247. Press [ok] to confirm.



INFO:

If the EFOY Pro fuel cell is disconnected from the battery the changed MODBUS address will be saved.

Check and adjust the MODBUS address when connecting the EFOY Pro fuel cell to a new network.

Via PC or Laptop:

With the SIO command "MODBUS" the configurations can be adjusted as well as the MODBUS RTU protocol can be activated.

A detailed description is available in the user manual for the interface adapter.

8.2.1.1 MODBUS RTU functions

The EFOY Pro MODBUS protocol is based on following Modbus specifications:

Modbus application protocol V1.1b3

Specific feature: Type RTC (Real Time Clock)

Use following bit field definition for decoding RTC types (e.g. system time and date):

```
struct {
    unsigned long second : 6; // seconds 0 to 59
    unsigned long minute : 6; // minutes 0 to 59
    unsigned long month : 4; // month 1 to 12
    unsigned long hour : 5; // hour 0 to 23
    unsigned long day : 5; // day 1 to 31
    unsigned long year : 6; // year - 2000 (max. 63)
};
```

Read Device Identification (Function code 0x2B)

Read out system information

Object ID	Name	Example	Type
0x00	VendorName	SFC Energy AG	STRING
0x01	ProductCode	123456-1234-56789	STRING
0x02	MajorMinorRevision	17.10	STRING
0x03	VendorUrl	http://www.sfc.com/	STRING
0x04	ProductName	EFOY Pro Series	STRING
0x06	UserApplicationName	Firmware EFOY Pro 2400 Duo E-V23 17.10I12V/24V QB date 2016-11-11	STRING

Input Register

Address	Name	Description	Unit	Multiplier	Type
30001	Tst	Stack temperature	°C	0,001	INT32
30003	Tint	Internal temperature	°C	0,001	INT32
30005	Twt	Heat exchanger temperature	°C	0,001	INT32
30007	Tdcdc	Periphery temperature	°C	0,001	INT32
30009	Tpcb	Periphery temperature	°C	0,001	INT32
30011	Tres	Periphery temperature	°C	0,001	INT32
30013	Taux	Periphery temperature	°C	0,001	INT32
30015	Ubat	Battery voltage	V	0,001	UINT16
30016	Uaus	Output voltage	V	0,001	UINT16
30017	Uklemm	Internal voltage	V	0,001	UINT16
30018	Uper	Internal voltage	V	0,001	UINT16
30019	UperIn	Internal voltage	V	0,001	UINT16
30020	Ust	Stack voltage	V	0,001	UINT16
30021	Uzell	Internal voltage	mV	0,1	UINT32
30023	ULF1	Internal voltage	V	0,001	UINT16
30024	Uref	Internal voltage	V	0,001	UINT16
30025	Ubb	Internal voltage	V	0,001	UINT16
30026	IntSteiu	Internal value	-	1	FLOAT
30028	laus	Output current	A	0,001	INT16
30029	lper	Periphery current	A	0,001	UINT16
30030	Ist	Stack current	A	0,001	UINT16
30031	Pst	Stack power	W	0,000001	UINT32
30033	Pper	Periphery power	W	0,001	INT32
30035	FuellSt	Reservoir fluid level	%	0,01	UINT16
30036	LastError	Last occurred error	-	1	UINT8
30037	Error	Current error	-	1	UINT8
30038	StBtrb	Operating hours stack	h	0,001	UINT32
30040	SysBtrb	Operating hours system	h	0,001	UINT32
30042	PcStack	Internal value	-	1	UINT8
30043	PcAux	Internal value	-	1	INT32
30045	ResF	Internal value	-	1	UINT16
30046	DHV	Internal value	-	1	FLOAT
30048	DC-DC	Internal value	-	0,086880973	INT16
30049	AdW	Internal value	-	1	UINT8
30050	FS	Fuel cartridge sensor FS1 status	-	1	UINT8

Address	Name	Description	Unit	Multiplier	Type
30051	SysTime	System time	h	1	RTC
30700	MeOH	Methanol consumption	l	0,000001	UINT32
30702	OnReason	Last switch on reason	-	1	UINT8
30703	OffReason	Last switch off reason	-	1	UINT16
30704	LoadDrops	Number of load disconnections	-	1	UINT8
30705	LastRun	Date of last stack run	-	1	RTC
30707	Mode	Operation mode: 0 - Manual Off 1 - Manual On 2 - Automatic 3 - Hybrid 4 - Ext. Control 5 - Transport lock	-	-	UINT16
30708	Status	Operation state: 1 - Standby 2 - Start phase 3 - Charging mode 4 - Shutdown procedure 5 - Antifreeze 6 - Battery protection 7 - Error 8 - Interruption 9 - Restart 10 - Transport lock	-	-	UINT16
30709	Warning	Warnings: Bit 0: Warning 141 Bit 1: Warning 176	-	-	UINT16
30711	CumOutP	Accumulated energy	Wh	1	INT32

Holding register

Address	Name	Description	Value	Type
41016	Cartridge Reset	Reset fuel gauge of cartridge port to 100 %. C: Connector DCS1: DuoCartSwitch DCS1	1: C#1 11: C#1 DCS1#1 12: C#1 DCS1#2 2: C#2 21: C#2 DCS1#1 22: C#2 DCS1#2 -1 : ALL	INT16
41996	Modbus Address	Set Modbus address	1 - 247	INT16
41998	Modbus Config	Set Modbus communication settings.	0: 9600 8,E,1 1: 9600 8,0,1 2: 9600 8,N,2 3: 9600 8,N,1	INT16
42000	Reset	Restart the fuel cell	0xBEAF	INT16
42002	Factory Defaults	Set all parameters to default	0xBEAF	INT16
42004	Hybrid	Deactivate all parameters.	0 : signal off 1 : signal on	INT16
42006	Plain text Protocol	Switch device to plain text interface.	0xBEAF	INT16
49999	IDSTATESEL	Select expert setting read property of selected ID. See chapter 8.2.1.2 "Overview ID list" on page 90.	0: selected value 1: default value 2: min value 3: max value	INT16

Holding register

Address	Name	Description	Value	Type
40990	IDSELECT	Select expert setting ID.	See chapter 8.2.1.2 "Overview ID list" on page 90.	UINT16
40991	IDVALUE	Read/write expert setting of selected ID.	See chapter 8.2.1.2 "Overview ID list" on page 90.	INT32
41000	Button	Change operation mode.	0: manual off 1: manual on 2: automatic	UINT16
41002	Cartridge Port 1	Configuration of cartridge port #1.	-1: DCS 0: disabled 1: M5 2: M10 3: M28	INT16
41004	Cartridge Port 11	Configuration of cartridge port #1.1.	1: M5 2: M10 3: M28	INT16
41006	Cartridge Port 12	Configuration of cartridge port #1.2.	1: M5 2: M10 3: M28	INT16
41008	Cartridge Port 2	Configuration of cartridge port #2.	-1: DCS 0: disabled 1: M5 2: M10 3: M28	INT16
41010	Cartridge Port 21	Configuration of cartridge port #2.1.	1: M5 2: M10 3: M28	INT16
41012	Cartridge Port 22	Configuration of cartridge port #2.2.	1: M5 2: M10 3: M28	INT16
41014	Active Cartridge Port	Set/get active cartridge port	1: #1 11: #1.1 12: #1.2 2: #2 21: #2.1 22: #2.2	INT16

Address	Name	Description	Value	Type
41016	Cartridge Select	Activate cartridge port. C: Connector DCS1: DuoCartSwitch DCS1	1: C#1 11: C#1 DCS1#1 12: C#1 DCS1#2 2: C#2 21: C#2 DCS1#1 22: C#2 DCS1#2	INT16
41020	Battery Type	Set battery type.	0: lead acid 1: lead gel 2: AGM 3: LiFePO4	INT16
41022	External Control	Software lock for external control.	0: Unlocked 1: Locked	INT16
41024	Battery Protect	Battery protection mode active.	0: Off 1: Active	INT16
41026	Fuel gauge Display	Fuel gauge state on Operating panel OP1.	0: Off 1: On	INT16
41028	Language	Adjust language on Operating panel OP1.	0: German 1: English 2: Italian 3: Spanish 4: French 5: Dutch	INT16
41030	External Remote	External software remote signal.	0: Off 1: On	INT16

8.2.1.2 Overview ID list

Profile	ID	Name	Standard	Min.	Max.
All	17	Reaction time for delayed switch on	60 s	2 s	300 s
All	24	Altitude of site up to	1500 m	0 m	2000 m
All	45	Full charge duration / Absorption time	180 min	0 min	300 min
Lead only	49	Max. output time (lead battery types)	24 h	2 h	120 h
12 V lead	18	Switch on voltage of lead type batteries (12V)	12300 mV	11000 mV	13000 mV
12 V lead	19	Switch off voltage of lead type batteries (12V)	14200 mV	13500 mV	14700 mV
12 V lead	20	Switch off current of lead type batteries (12V)	4000 mA	2000 mA	10000 mA
12 V lead	46	Battery protection of lead type batteries (12V)	11200 mV	10500 mV	12000 mV
12 V lead	74	Charge voltage (hybrid) of lead type batteries (12V)	14700 mV	13500 mV	15500 mV
24 V lead	21	Switch on voltage of lead type batteries (24V)	24600 mV	22000 mV	26000 mV
24 V lead	22	Switch off voltage of lead type batteries (24V)	28400 mV	27000 mV	29400 mV
24 V lead	23	Switch off current of lead type batteries (24V)	2000 mA	1000 mA	5000 mA
24 V lead	47	Battery protection of lead type batteries (24V)	22400 mV	21000 mV	24000 mV
24 V lead	75	Charge voltage (hybrid) of lead type batteries (24V)	29400 mV	27000 mV	31000 mV
LiFePO4 only	77	Max. output time (LiFePO4 battery types)	48 h	2 h	120 h
12 V LiFePO4	25	Switch on voltage of LiFePO4 type batteries (4 cells)	12600 mV	12000 mV	13400 mV
12 V LiFePO4	26	Switch off voltage of LiFePO4 type batteries (4 cells)	14500 mV	13800 mV	14600 mV
12 V LiFePO4	27	Switch off current of LiFePO4 type batteries (4 cells)	4000 mA	2000 mA	10000 mA
12 V LiFePO4	48	Battery protection of LiFePO4 type batteries (4 cells)	11000 mV	10500 mV	12500 mV

Profile	ID	Name	Standard	Min.	Max.
12 V LiFePO4	76	Charge voltage (hybrid) of LiFePO4 type batteries (4 cells)	14600 mV	13800 mV	15500 mV
24 V LiFePO4	78	Switch on voltage of LiFePO4 type batteries (8 cells)	25200 mV	24000 mV	26800 mV
24 V LiFePO4	79	Switch off voltage of LiFePO4 type batteries (8 cells)	29000 mV	27600 mV	29200 mV
24 V LiFePO4	80	Switch off current of LiFePO4 type batteries (8 cells)	2000 mA	1000 mA	5000 mA
24 V LiFePO4	81	Battery protection of LiFePO4 type batteries (8 cells)	22000 mV	21000 mV	25000 mV
24 V LiFePO4	82	Charge voltage (hybrid) of LiFePO4 type batteries (8 cells)	29200 mV	27600 mV	31000 mV

Recommended way to read expert setting parameter:

1. Write (command 0x10) desired expert setting ID to MODBUS Register 40990 (IDSELECT)
2. Use a combined read & write (command 0x17), write setting property to read to 49999 (IDSTATESEL) and read 40991 (IDVALUE).

Recommended way to write expert setting parameter:

Write desired expert setting ID to MODBUS register 40990 (IDSELECT) and desired value to 40991 (IDVALUE) using command (0x10).

8.2.2 SIO / Plain text

Following commands are available in the clear text protocol:

Command	Description
?	Display command overview.
BATTERY	Select battery type
BATTERYPROTECTION	Control battery protection
BUTTON	Software control of device
CARTRIDGE	Set/view connected fuel cartridges/DuoCartSwitch
CONFIG	Set customized operation parameters
DEFAULT	Apply default operation parameters
ERROR	Show ten most recent errors
FEULGAUGE	Enable/disable fuel gauge
GET	Get customized operation parameter
HYBRID	Switch the device from automatic into hybrid mode for 15s
LANGUAGE	Set language in Operating panel OP2
LIMITS	Show min. and max. values of operation parameters
LOCKED	Lock control contacts
LOG	Show details of current operation state
MODBUS	Settings of MODBUS protocol
REMOTE	Remote control via software interface
RESET	Restart the device
SERIAL	Show the device's serial numbers
SET	Set customized operation parameter
SFC	Show current operation state
STDVALUE	Show default values of operation parameters
SYSTEM	Reason for last start-up and stop
VALUE	Show current values of operation parameters
VER	Show version of firmware

A detailed description is available in the user manual for the interface adapter.

8.3 GSM modem

The optional GSM modem enables you to monitor and control the EFOY Pro fuel cell remotely. It is recommended to use such a solution for autonomous operation of the EFOY Pro.

Functions

- Notification if errors occur
- Notification if fuel cartridge falls below the reserve (with optional fuel cartridge sensor FS1)
- Remote diagnostics
- Remote control
- Remote parameter adjustment
- Firmware update via GSM modem

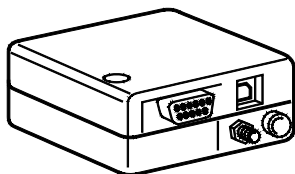

A detailed description is available in the "GSM Modem GSM" user manual.

8.4 Fuel cartridge sensor FS1

By default, the EFOY Pro does not monitor the actual fill level of the fuel cartridge. The fuel gauge for the fuel cartridge is just an indicator and calculates the methanol consumption. The FS1 fuel cartridge sensor must be used to measure the actual fill level. The EFOY Pro reports a fuel level error if the cartridge is used up.

The optional fuel cartridge sensor FS1 indicates if the fuel level drops below the position of the sensor. This early warning gives the user time to change the cartridge before it is completely empty.

The fuel cartridge sensor FS1 may also be used with fuel cartridges that are partly empty. It sends a signal to the EFOY Pro fuel cell when the fill level falls below the sensor.

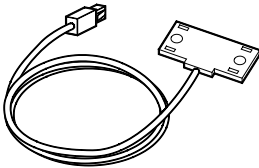

You connect the sensor to the EFOY Pro data interface.

The sensor should be combined with a remote monitoring system, e.g. the GSM modem.

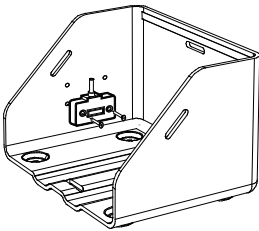

You fasten the fuel cartridge sensor to the fuel cartridge holder using two screws. You can choose from two different heights to mount the FS1.

A detailed description is available in the user manual "Fuel cartridge sensor FS1".

8.5 Cluster controller CC1

The cluster controller combines 3 functions:

- Interface splitter (provides 2 sockets)
- Parallel operation of up to 5 EFOY Pros
- Remote control of one EFOY Pro (Remote-on pin)

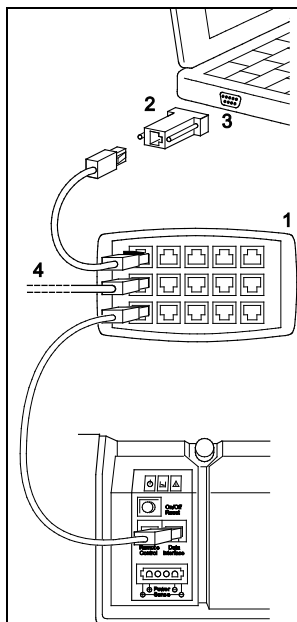

1. Cluster controller CC1
2. Interface adapter IA1
3. Computer connection (COM)
4. to fuel cartridge sensor FS1

A detailed description is available in the user manual for the cluster controller.

Interface splitter:

The cluster controller splits the data interface and provides two sockets to connect the interface adapter and the fuel cartridge sensor together.



INFO :

A power supply is not available at the interfaces.

Parallel operation:

For high power requirements you can connect up to five devices in parallel using the optional cluster controller CC1. The devices switch charging mode on and off together.

Devices running in parallel must all be in the same operating mode (e.g. all in automatic mode) and the "External control" operating mode must be enabled.

All EFOY Pro fuel cells must have the same settings to run in parallel.

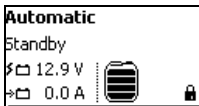
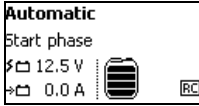
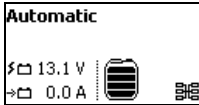

The cluster icon is displayed at the bottom right of the display for EFOY Pro devices running in parallel.

Remote control (remote-on):

The EFOY Pro can be controlled externally using a switching contact on the CC1, which means that the charging mode can be started.

The same function can also be enabled via the computer interface.

If the device is in "Remote Control" mode, "RC" (Remote Control) appears at the bottom right of the display.

If you have not enabled external control, (see chapter 5.5 "Operating modes" on page 59), a padlock appears at the bottom right of the display.

A detailed description is available in the user manual Cluster Controller CC1.

8.6 DuoCartSwitch DCS 1

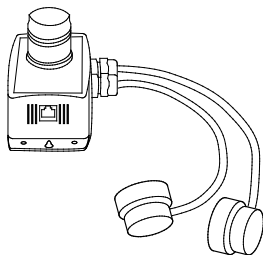

The DuoCartSwitch enables you to connect two fuel cartridges to the cartridge connector of one EFOY Pro fuel cell. The switching valve switches automatically from the fuel cartridge in operation to the reserve fuel cartridge. This means that the autonomy of the application can be doubled.

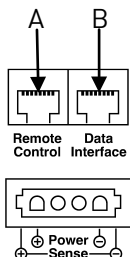

1. Screw the fuel-cartridge connector of the EFOY Pro on the DuoCartSwitch.
2. Connect one DuoCartSwitch via a Port Doubler to each RJ45-plug of the EFOY Pro:
 - A: Remote Control plug
 - B: Data Interface plug



CAUTION!

Only connect one DuoCartSwitch to each RJ45-plug (Remote Control / Data Interface). If both DuoCartSwitch are connected to one RJ45-plug the switching of the DuoCartSwitch fuel connectors malfunctions, which might damage the EFOY Pro fuel cell.

3. For activation of the DuoCartSwitch see chapter 5.2 "Operation via the operating panel" on page 36.

A detailed description is available in the user manual DuoCartSwitch DCS1.

9 Appendix

9.1 U-I and U-P characteristic

EFOY Pro 800: U-I and U-P characteristic

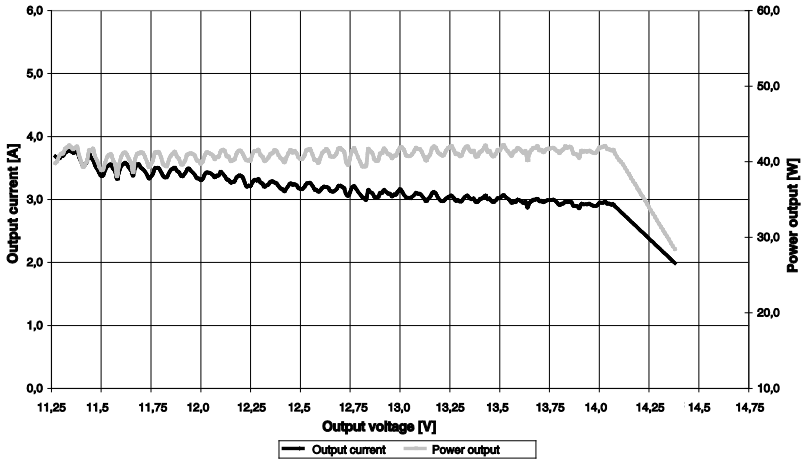

EFOY Pro 2400: U-I and U-P characteristic

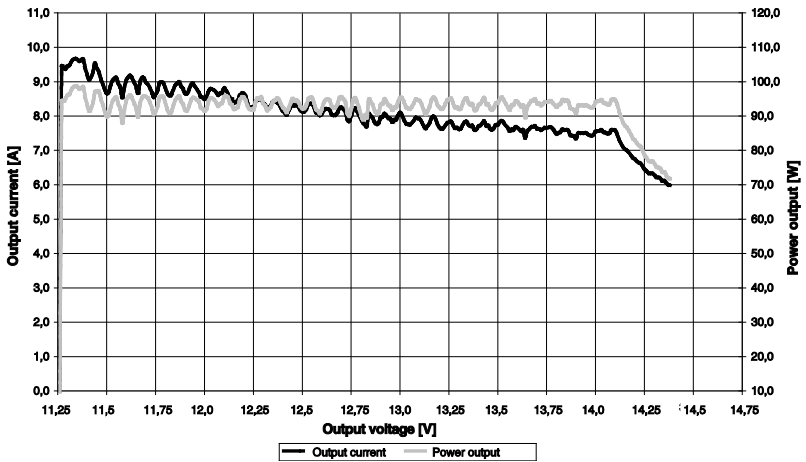

9.2 Output power characteristic

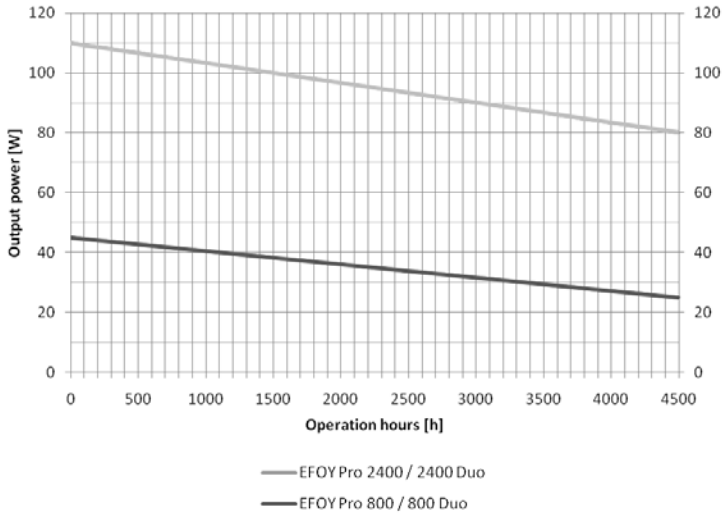

- This page is intentionally left blank-